Giydirme Cephe Sistemi
Curtain Facade System











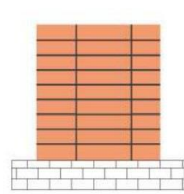
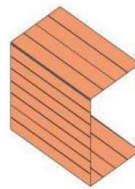
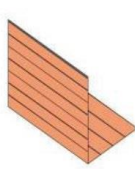
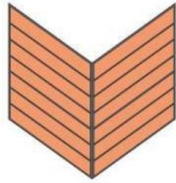
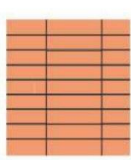
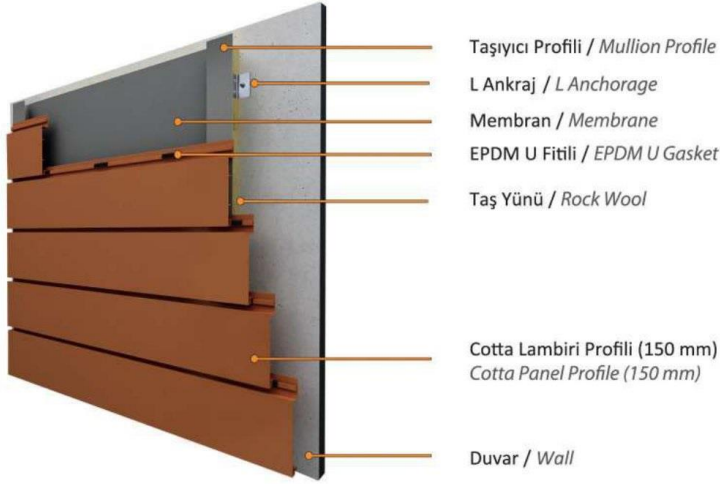



AC22

Cotta Cephe Sistemi
Cotta Facade System

TEKNİK ÖZELLİKLER / TECHNICAL PROPERTIES

Profil Geniřlięi / Profile Width	22 mm
Profil Et Kalınlıęı / Profile Wall Thickness	1,6 mm
Düřey Tařıyıcı Profil Yükseklięi / Mullion Profile Height	150 - 218 mm



PROFİL KESİTİ PROFILE SECTION	PROFİL KODU PROFILE CODE	PROFİL ADI PROFILE NAME	lx cm	ly cm	AĞIRLIK (kg/m) WEIGHT
	8600	COTTA LAMBRI PROFİLİ (150 mm) COTTA PANNELING PROFILE			1,214 kg/mt
	8500	COTTA LAMBRI PROFİLİ (218 mm) COTTA PANNELING PROFILE			1,482 kg/mt
	10388	COTTA LAMBRI PROFİLİ (250 mm) COTTA PANNELING PROFILE			1,705 kg/mt
	10393	DERZ KANALLI TAŞIYICI PROFİLİ CARRIER PROFILE			0,715 kg/mt
	9790	TAŞIYICI PROFİLİ CARRIER PROFILE			0,529 kg/mt
	6525	ALT-ÜST BİTİŞ PROFİLİ BOTTOM-TOP FINISH PROFILE			0,433 kg/mt
	627	KUTU PROFİLİ BOX PROFILE			1,040 kg/mt
	10389	KÖŞE DÖNÜŞ PROFİLİ CORNER PROFILE			0,691 kg/mt
	8603	KÖŞE DÖNÜŞ PROFİLİ CORNER PROFILE			0,620 kg/mt
	8503	KÖŞE DÖNÜŞ PROFİLİ CORNER PROFILE			0,651 kg/mt
	8502	KÖŞE DÖNÜŞ PROFİLİ CORNER PROFILE			0,984 kg/mt
	8501	KÖŞE DÖNÜŞ PROFİLİ CORNER PROFILE			0,984 kg/mt

AKSESUAR ACCESSORY	STOK KODU REFERENCE CODE	AKSESUAR ADI DESCRIPTION	AKSESUAR KODU PRODUCT CODE	PAKET PACK
	03 010331	EPDM U FİTİLİ EPDM U GASKET	AC22-CYF.20	215 mt \ 10 kg
	11 010410	M10X100 PASLANMAZ ÇELİK DÜBEL M10X100 STAINLESS STEEL DOWEL	AC22-ÇD.410	1 pk \ 100 ad
	11 010292	YHB Ø3.9x19mm MATKAP UÇLU VİDA SCREW	AC22-SC.292	1 pk / 1000 ad
	01 100156	80X40'LİK DUVAR BAĞLANTISI L ANKRAJ 8 cm (40X60X80X3 mm) (40X60X80X3 mm) ANCHORAGE	AC22-DBA.L80	2 adet
	01 100155	DÖŞEME BAĞLANTISI L ANKRAJ (40X60X150X3 mm) (40X60X80X3 mm) ANCHORAGE	AC22-DBA.L150	2 adet
	01 100157	KÖŞE DÖNÜŞ DÖŞEME BAĞLANTI L ANKRAJ (75X140X150X4mm) (75X140X150X4 mm) ANCHORAGE	AC22-KDBA.L150	2 adet
	11 010412	M5X25mm CİVATA+M5 SOMUN SCREW NUT	AC22-SC.412	1 pk \ 100 ad
	11 011851	APBMUV Ø5 x 32 mm ALTIKÖŞE PUL BAŞLI MATKAP UÇLU VİDA (TRAPEZ) SCREW	AC22-SC.851	1pk / 500 ad
	08 100301	MEMBRAN EPDM (0,5 mmx1300mmx37,5mt) MEMBRANE	AC22-MB.301	1 rulo\48,75 mt

** Her profil için minimum sipariş 300 kg'dır.
** Minimum order quantity is 300 kg per profile.

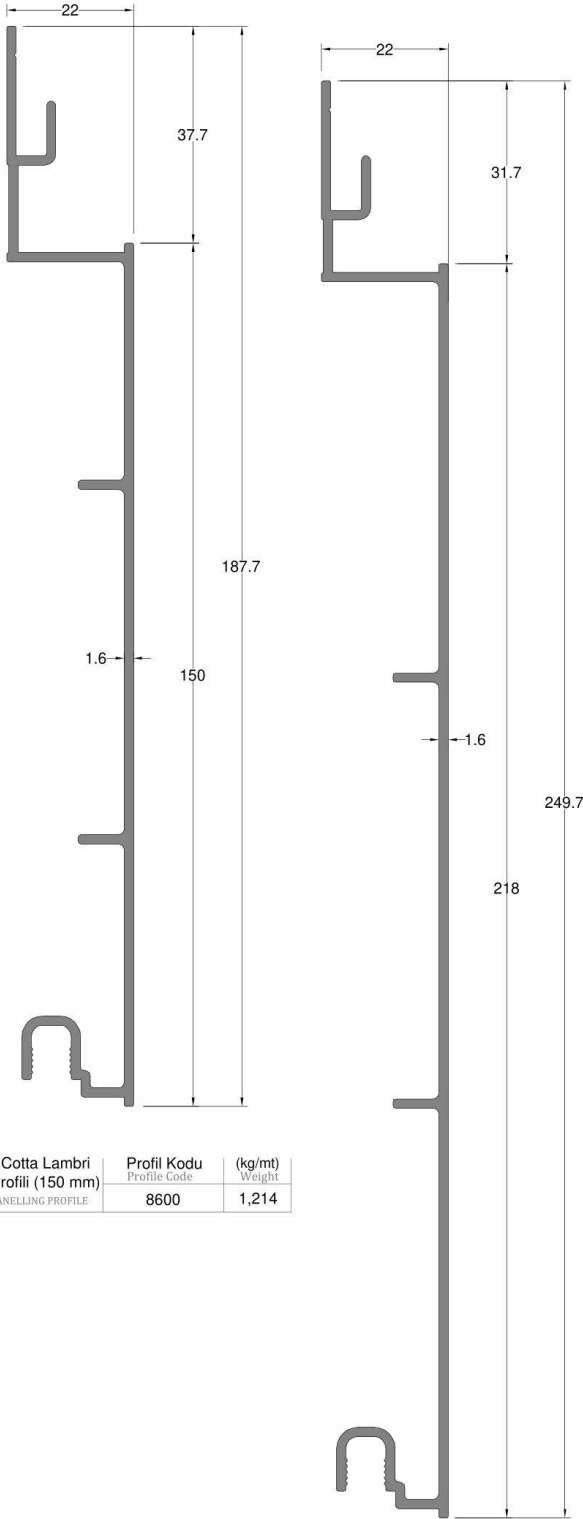

Cotta Lambri Profili (150 mm)	Profil Kodu Profile Code	(kg/mt) Weight
PANELLING PROFILE	8600	1,214

Cotta Lambri Profili (218 mm)	Profil Kodu Profile Code	(kg/mt) Weight
PANELLING PRO FILE	8500	1,482

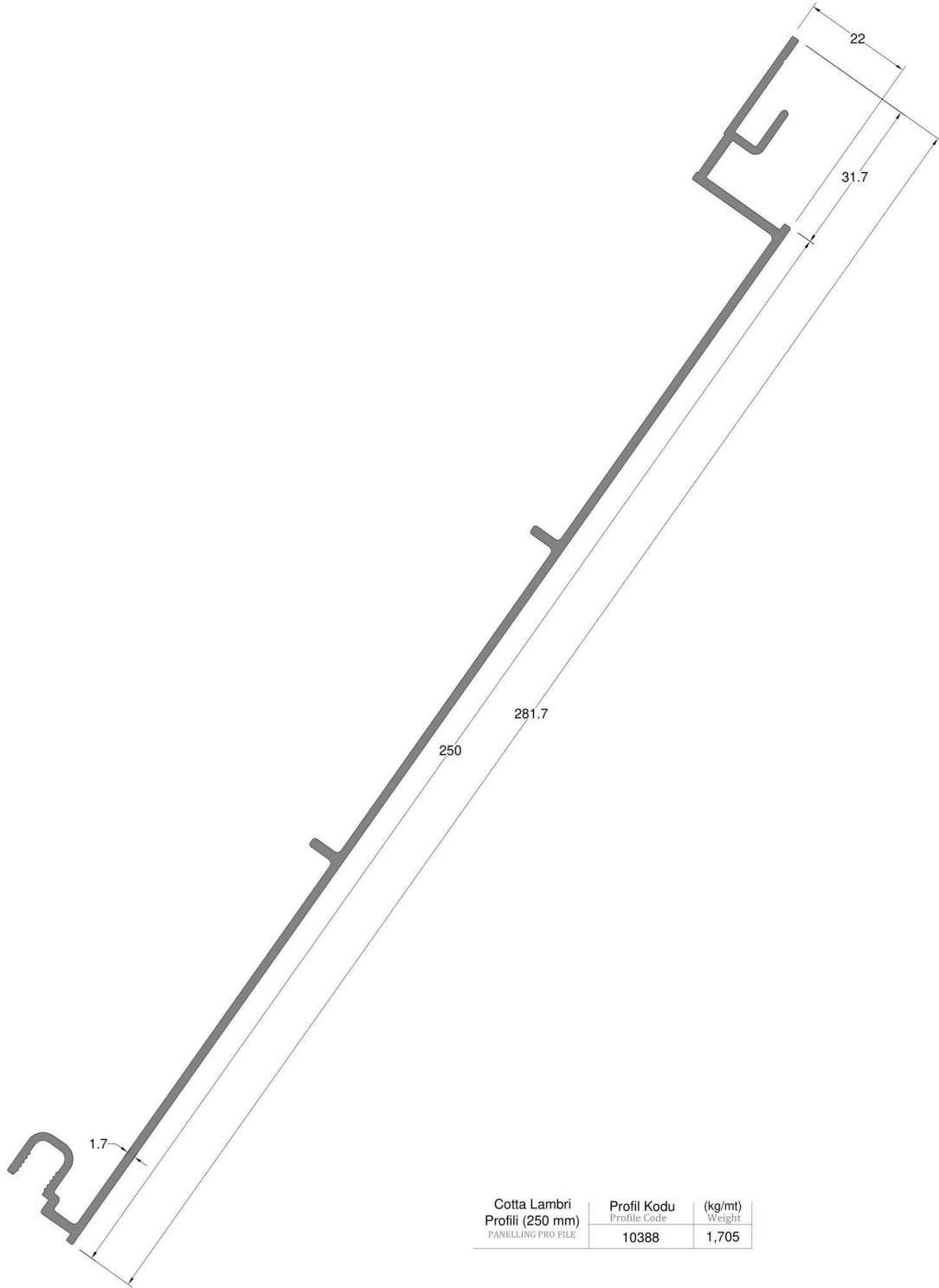

Cotta Lambri Profili (250 mm) PANELLING PRO FILE	Profil Kodu Profile Code	(kg/mt) Weight
	10388	1,705

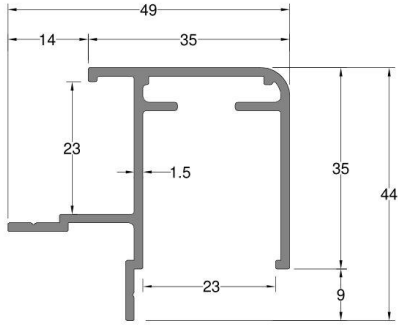

Köşe Dönüş Profili	Profil Kodu	(kg/mt)
CORNER PRO FILE	Profile Code	Weight
	8603	0,621

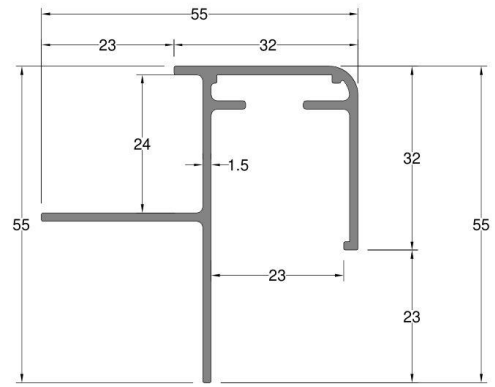

Köşe Dönüş Profili	Profil Kodu	(kg/mt)
CORNER PRO FILE	Profile Code	Weight
	8503	0,651

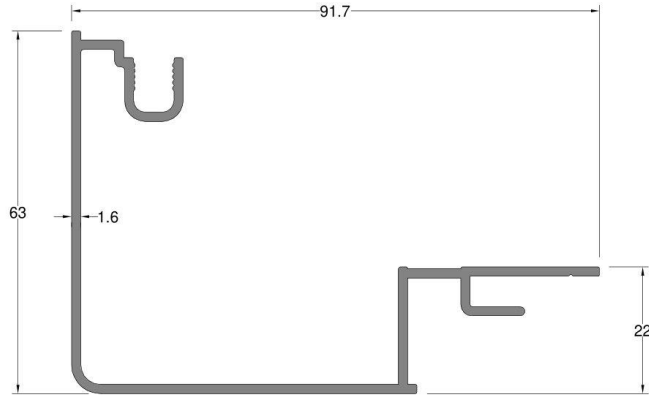

Köşe Dönüş Profili	Profil Kodu	(kg/mt)
CORNER PRO FILE	Profile Code	Weight
	8502	0,984

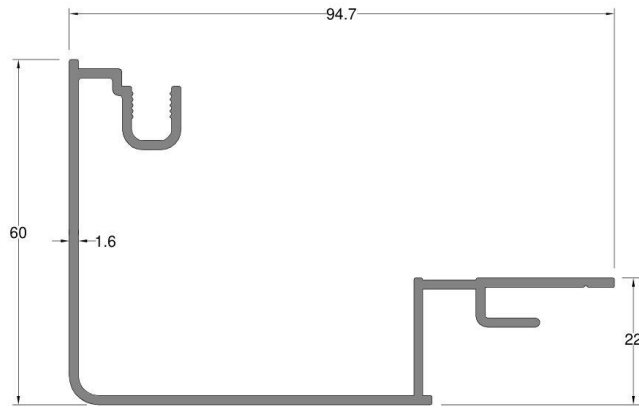

Köşe Dönüş Profili	Profil Kodu	(kg/mt)
CORNER PRO FILE	Profile Code	Weight
	8501	0,984

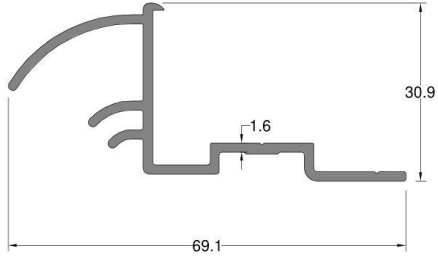

Açılı Dönüş Profili	Profil Kodu	(kg/mt)
CORNER PRO FILE	Profile Code	Weight
	10389	1,691

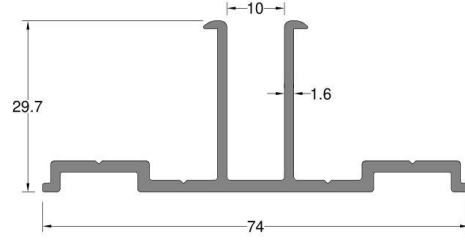

Derz Kanallı Taşıyıcı Profili	Profil Kodu	(kg/mt)
CARRIER PROFILE	Profile Code	Weight
	10393	0,715

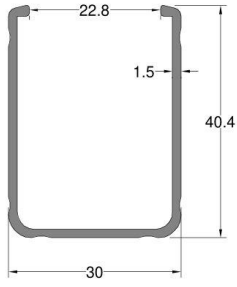

Alt-Üst Bitiş Profili	Profil Kodu	(kg/mt)
BOTTOM-TOP FINISH PROFILE	Profile Code	Weight
	6525	0,433

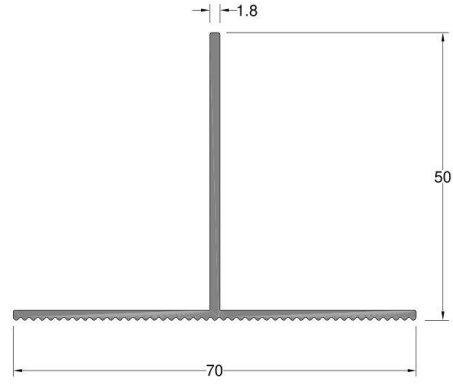

Taşıyıcı Profili	Profil Kodu	(kg/mt)	Jx cm ⁴	Jy cm ⁴
CARRIER PROFILE	Profile Code	Weight		
	9790	0,529	4,65	4,45

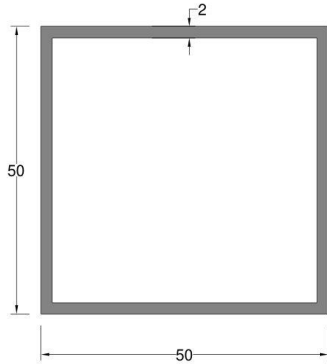

Kutu Profili	Profil Kodu	(kg/mt)
BOX PROFILE	Profile Code	Weight
	627	1,040

