

Kapı ve Pencere Sistemi
Window and Door System

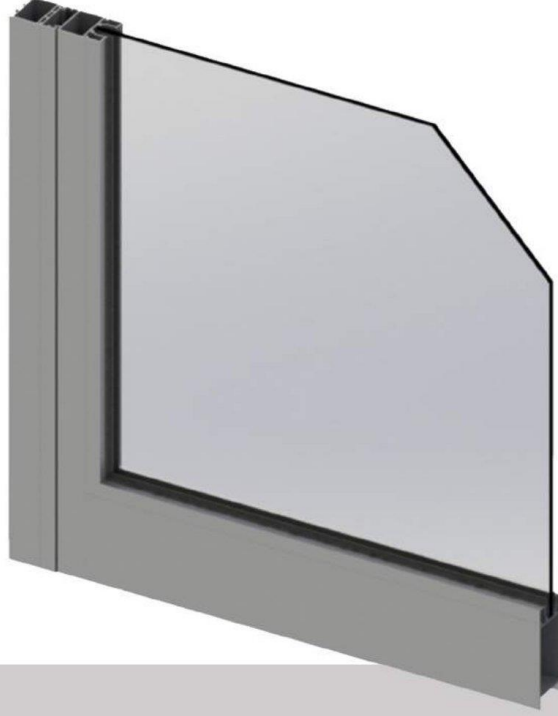

W D 60

Kapı ve Pencere Sistem
Window and Door System

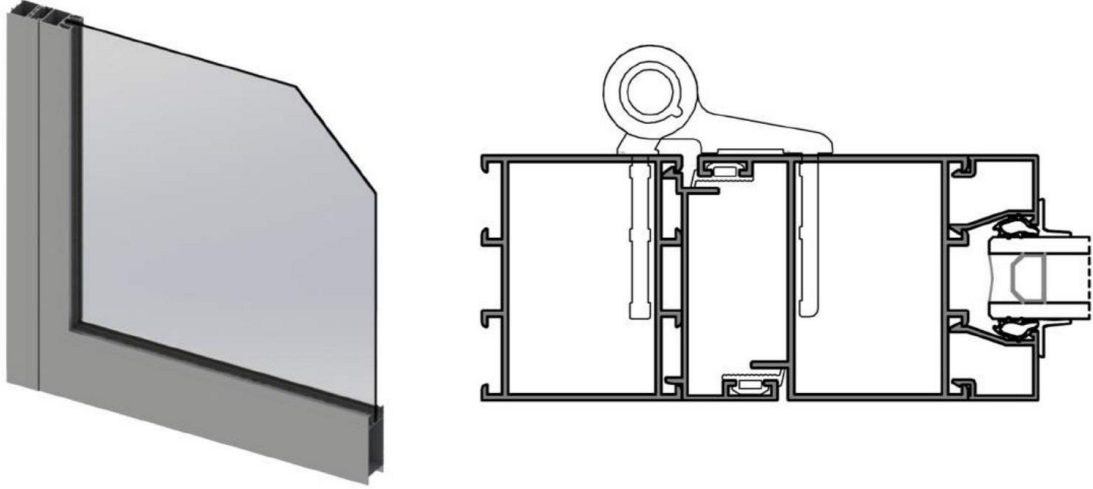

TEKNİK ÖZELLİKLER / TECHNICAL PROPERTIES

KASA DERİNLİĞİ / FRAME DEPTH	60 mm
KANAT DERİNLİĞİ / SASH DEPTH	60 mm
ET KALINLIĞI / WALL THICKNESS	1,2 - 1,5 - 1,6 - 2 mm
MIN/MAX CAM KALINLIĞI / MIN/MAX GLASS THICKNESS	4-28 mm
ISI BARIYER / THERMAL BREAK	-

UYGULAMA SEÇENEKLERİ / APPLICATION OPTIONS

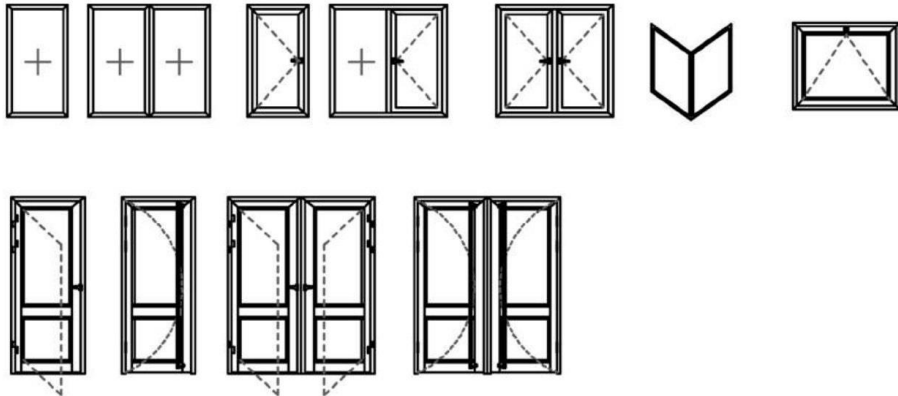





















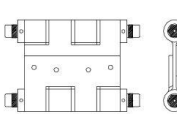





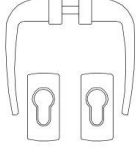



PROFİL KESİTİ PROFILE SECTION	PROFİL KODU PROFILE CODE	PROFİL ADI PROFILE NAME	Jx cm ⁴	Jy cm ⁴	AĞIRLIK (kg/m) WEIGHT
	478	DAR KASA PROFİLİ FRAME PROFILE	-	-	0,770kg/mt
	530	DAR KASA PROFİLİ FRAME PROFILE	-	-	0,826kg/mt
	2021	KASA PROFİLİ FRAME PROFILE	-	-	1,264 kg/mt
	452	KASA PROFİLİ FRAME PROFILE	-	-	1,013 kg/mt
	569	KASA PROFİLİ FRAME PROFILE	-	-	0,861kg/mt
	521	KASA PROFİLİ FRAME PROFILE	-	-	1,290 kg/mt
	522	KASA PROFİLİ FRAME PROFILE	-	-	1,029 kg/mt
	705	TAKVİYELİ KASA PROFİLİ REINFORCED FRAME PROFILE	-	-	1,914 kg/mt
	6080	KANAT PROFİLİ SASH PROFILE	-	-	0,888 kg/mt
	2020	KANAT PROFİLİ SASH PROFILE	-	-	1,339 kg/mt
	451	KANAT PROFİLİ SASH PROFILE	-	-	1,064 kg/mt
	475	GENİŞ KANAT PROFİLİ WIDE SASH PROFILE	-	-	1,381 kg/mt
	457	GENİŞ KASA-KANAT PROFİLİ WIDE FRAME-SASH PROFILE	-	-	1,419 kg/mt
	456	ETEK PROFİLİ BOTTOM PROFILE	-	-	2,112 kg/mt
	518	ETEK PROFİLİ BOTTOM PROFILE	-	-	1,621 kg/mt
	7396	ETEK PROFİLİ BOTTOM PROFILE	-	-	1,435 kg/mt
	453	KÖŞE DÖNÜŞ PROFİLİ CORNER PROFILE	-	-	1,059 kg/mt
	700	ADAPTÖR PROFİLİ ADAPTER PROFILE	-	-	0,370 kg/mt
	704	ADAPTÖR PROFİLİ ADAPTER PROFILE	-	-	0,410 kg/mt



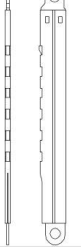

** Her profil için minimum sipariş 300 kg'dır.
** Minimum order quantity is 300 kg per profile.

PROFİL KESİTİ PROFILE SECTION	PROFİL KODU PROFILE CODE	PROFİL ADI PROFILE NAME	Jx cm ⁴	Jy cm ⁴	AĞIRLIK (kg/m) WEIGHT
	6975	ÇİTA PROFİLİ BEAD PROFILE	-	-	0,203 kg/mt
	455	ÇİTA PROFİLİ BEAD PROFILE	-	-	0,207 kg/mt
	2023	ÇİTA PROFİLİ BEAD PROFILE	-	-	0,277 kg/mt
	454	ÇİTA PROFİLİ BEAD PROFILE	-	-	0,228 kg/mt
	2022	ÇİTA PROFİLİ BEAD PROFILE	-	-	0,262 kg/mt
	2279	ÇİTA PROFİLİ BEAD PROFILE	-	-	0,236 kg/mt
	509	ÇİTA PROFİLİ BEAD PROFILE	-	-	0,277 kg/mt
	2273	ÇİTA PROFİLİ BEAD PROFILE	-	-	0,336 kg/mt
	5786	ÇİTA PROFİLİ BEAD PROFILE	-	-	0,363 kg/mt
	2281	ÇİTA PROFİLİ BEAD PROFILE	-	-	0,363 kg/mt
	508	KÖŞE ÇAVUŞ BAĞLANTI PROFİLİ CORNER JOINT PROFILE	-	-	1,112 kg/mt
	458	DİK BĞLANTI PROFİLİ CONNECTION PROFILE	-	-	1,508 kg/mt
	410	KÖŞE BAĞLANTI TAKOZ PROFİLİ CORNER WEDGE PROFILE	-	-	6,094g/mt
	701	ADAPTÖR PROFİLİ ADAPTER PROFILE	-	-	0,380 kg/mt
	510	ADAPTÖR PROFİLİ ADAPTER PROFILE	-	-	0,255 kg/mt
	5601	ADAPTÖR PROFİLİ ADAPTER PROFILE	-	-	0,216 kg/mt
	2030	EK ADAPTÖR PROFİLİ ADAPTER PROFILE	-	-	0,247 kg/mt
	481	KASA ADAPTÖR PROFİLİ FRAME ADAPTER PROFILE	-	-	0,183 kg/mt

** Her profil için minimum sipariş 300 kg'dır.
** Minimum order quantity is 300 kg per profile.

AKSESUAR ACCESSORY	STOK KODU REFERENCE CODE	AKSESUAR ADI DESCRIPTION	AKSESUAR KODU PRODUCT CODE	PAKET PACK
	03 020501	HORTUMLU CAM FİTİLİ 6MM BUBBLED GLAZING GASKET 6 MM	WD60-HCF.60	1pk / 100 mt
	03 020502	HORTUMLU CAM FİTİLİ 4MM BUBBLED GLAZING GASKET 4 MM	WD60-HCF.40	1pk / 100 mt
	03 020503	HORTUMLU CAM FİTİLİ 3MM BUBBLED GLAZING GASKET 3 MM	WD60-HCF.30	1pk / 100 mt
	03 070106	KAMA FİTİLİ 2319 (2MM) EPDM GASKET 2319 (2 MM)	WD60-KF.20	1 pk / 250 mt
	03 070103	KAMA FİTİLİ 2300(3MM) EPDM GASKET 2300 (3MM)	WD60-KF.30	1 pk / 200 mt
	03 070101	KAMA FİTİLİ 2209 (4MM) EPDM GASKET 2209 (4 MM)	WD60-KF.40	1 pk / 140 mt
	03 070105	KAMA FİTİLİ 2210 (5MM) SPLINE GASKET 2210 (5MM)	WD60-KF.50	1 pk / 135 mt
	03 015517	KAMA FİTİLİ 5517 (6MM) EPDM GASKET 5517 (6 MM)	WD60-KF.60	1 pk / 100 mt
	03 020211	C60 KANAT FİTİLİ C60 SASH GASKET	WD60-CF.211	1 pk / 150 mt
	01 150200	ALÜMİNYUM KAPI ALTI FIRÇASI ALUMINUM DOORBASE BRUSH	WD60-KF.200	1 pk/ 100 ad
	03 050712	FIRÇA FİTİL (6,8x10 mm) WEATHER STRIP (6,8x10 mm)	WD60-FÇ.712	1 pk / 200 mt
	01 010801	YAPRAK MENTEŞE (ELOKSAL) BACKFLAP HINGE (ANODIZED)	WD60-YM.801	1 koli/ 100 ad
	01 010802	YAPRAK MENTEŞE (BEYAZ) BACKFLAP HINGE (WHITE)	WD60-YM.802	1 koli/ 100 ad
	01 010803	YAPRAK MENTEŞE (RENKLİ) BACKFLAP HINGE (COLORED)	WD60-YM.803	1 koli/ 100 ad
	01 010701	TAKOZLU MENTEŞE (ELOKSAL) WEDGE HINGE (ANODIZED)	WD60-TM.701	1 koli/ 50 ad
	01 010702	TAKOZLU MENTEŞE (BEYAZ) WEDGE HINGE (WHITE)	WD60-TM.702	1 koli/ 50 ad
	01 010703	TAKOZLU MENTEŞE (RENKLİ) WEDGE HINGE (COLORED)	WD60-TM.703	1 koli/ 50 ad
	01 012206	ÇARPMA KAPI MENTEŞE (ELOKSAL) OUTWARD OPENING OVERLAPPING HINGE (ANODIZED)	WD60-ÇM.206	1 pk / 1 ad
	01 012202	ÇARPMA KAPI MENTEŞE (BEYAZ) OUTWARD OPENING OVERLAPPING HINGE (WHITE)	WD60-ÇM.202	1 pk / 1 ad
	01 012208	YAYLI MENTEŞE BESLEME ÇITASI SPRING HINGE SUPPLY BAR	WD60-BÇ.208	1 pk / 2 ad
	01 012101	YAYLI MENTEŞE NO:33 KADYUMLU SPRING HINGE NO:33 CADRUM	WD60-YM.101	1 pk / 2 ad
	01 031201	YAY KOL (ELOKSAL) BOWED HANDLE (ANODIZED)	WD60-YK.201	1 pk / 10 ad

AKSESUAR ACCESSORY	STOK KODU REFERENCE CODE	AKSESUAR ADI DESCRIPTION	AKSESUAR KODU PRODUCT CODE	PAKET PACK
	01 031201	YAY KOL (ELOKSAL) BOWED HANDLE (ANODIZED)	WD60-YK.201	1 pk / 10 ad
	01 031350	KÖŞELİ H KOL (ELOKSAL) ANGULAR H HANDLE (ANODIZED)	WD60-KHK.350	1 pk / 10 ad
	01 040902	FORZA KAPI KOL (BEYAZ) FORZA DOOR HANDLE (WHITE)	WD60-FK.902	1 pk / 10 ad
	01 040903	FORZA KAPI KOLU (RENKLİ) FORZA DOOR HANDLE (COLORED)	WD60-FK.903	1 pk / 10 ad
	01 040904	FORZA KAPI KOLU (NATÜREL) FORZA DOOR HANDLE (NATURAL)	WD60-FK.904	1 pk / 10 ad
	01 031901	LAMA BANT KOL 90 cm-100 cm (ELOKSAL) 90 cm - 100 cm STRAP SHEET HANDLE (ANODIZED)	WD60-LBK.901	1 pk / 2 ad
	01 030401	25 mm 30 cm KIVRIK KOL (ELOKSAL) 25 mm 30 cm CONVOLUTED HANDLE (ANODIZED)	WD60-KK.401	1 pk / 10 ad
	01 030901	YARIM AY KAPI KOLU (ELOKSAL) SEMI-CIRCULAR DOOR HANDLE (ANODIZED)	WD60-YAK.901	1 pk / 1 ad
	01 040104	YAYLI SOSİS KOL (ELOKSAL) SPRING TUBULAR HANDLE (ANODIZED)	WD60-YSK.104	1 pk / 1 ad
	01 070501	SAVYO SÜRGÜ (ELOKSAL) SAVIO LATCH (ANODIZED)	WD60-SS.501	1 pk / 12 ad
	01 130212	ORTA KAYIT BAĞLANTI SAC SHEET METAL MULLION CONNECTION	WD60-KB.212	1 pk / 100 ad
	01 031309	H KOL (ELOKSALLI) H-SHAPED HANDLE (ANODIZED)	WD60-HK.309	1 pk / 10 ad
	01 081000	AYARLI 5 KADEMELİ MAKAS ADJUSTABLE TRUSS (ANODIZED)	WD60-KM.1000	1 pk / 10 ad
	01 081001	AYARLI 3 KADEMELİ MAKAS ADJUSTABLE TRUSS (ANODIZED)	WD60-KM.1001	1 pk / 10 ad
	01 081501	VASİSTAS ÇARPMA (ELOKSAL) TRANSOM CATCH (ANODIZED)	WD60-VÇ.501	1 pk / 50 ad
	01 031101	AKBANK KOL APARATI OVAL (ELOKSAL) AKBANK OVAL HANDLE TOOL (ANODIZED)	WD60-DKK.101	1 pk / 1 ad
	01 031104	AKBANK KOL APARATI AKBANK HANDLE TOOL	WD60-AKA.104	1 pk / 1 ad
	01 160103	PANİK BAR BARELSİZ DOOR HANDLE (ANODIZED)	WD60-PBB.103	1 pk / 1 ad
	01 160106	PANİK BAR KOLU (KİLİTLENEBİLİR) DOOR HANDLE (LOCK WITH KEY)	WD60-PBK.106	1 pk / 1 ad
	01 060201	WD60 KİLİT KARŞILIĞI (ELOKSAL) WD60 LOCK STRIKER (ANODIZED)	WD60-KK.201	1 pk / 1 ad

AKSESUAR ACCESSORY	STOK KODU REFERENCE CODE	AKSESUAR ADI DESCRIPTION	AKSESUAR KODU PRODUCT CODE	PAKET PACK
	05 010201	BARELLİ MAKARALI KİLİT ROLLER LOCK	WD60-MK.201	1 pk / 1 ad
	05 010110	BARELLİ DİLLİ KİLİT BOLT LOCK	WD60-DK.110	1 pk / 1 ad
	01 020702	FORZA EKSENEL PENCERE KOL (BEYAZ) FORZA AXIAL WINDOW HANDLE (WHITE)	WD60-FPK.702	1 pk / 20 ad
	01 020703	FORZA EKSENEL PENCERE KOL (RENKLİ) FORZA AXIAL WINDOW HANDLE (COLORED)	WD60-FPK.703	1 pk / 20 ad
	01 020803	FORZA EKSENEL PENCERE KOL (NATUREL) FORZA AXIAL HANDLE (NATURAL)	WD60-FPK.803	1 pk / 20 ad
	01 080101	13 CM VASİSTAS MAKAS (ELOKSALLI) SYSTEM 13 CM TRANSOM TRUSS (ANODIZED)	WD60-VM.101	1 pk / 50 ad
	01 080102	13 CM VASİSTAS MAKAS (BEYAZ) SYSTEM 13 CM TRANSOM TRUSS (WHITE)	WD60-VM.102	1 pk / 50 ad
	01 080103	13 CM VASİSTAS MAKAS (RENKLİ) SYSTEM 13 CM TRANSOM TRUSS (COLORED)	WD60-VM.103	1 pk / 50 ad
	01 080201	22 CM VASİSTAS MAKAS (ELOKSALLI) SYSTEM 22 CM TRANSOM TRUSS (ANODIZED)	WD60-VM.201	1 pk / 50 ad
	01 080202	22 CM VASİSTAS MAKAS (BEYAZ) SYSTEM 22 CM TRANSOM TRUSS (WHITE)	WD60-VM.202	1 pk / 50 ad
	01 080203	22 CM VASİSTAS MAKAS (RENKLİ) SYSTEM 22 CM TRANSOM TRUSS (COLORED)	WD60-VM.203	1 pk / 50 ad
	11 011037	4,8X25 mm YHB SAC VİDA 4,8X25 mm SCREW (STRAIGHT TOP)	WD60-SC.37	1 pk / 1000 ad

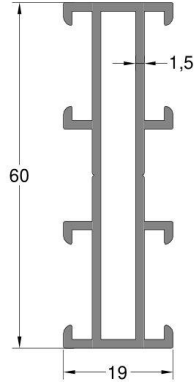

Dar Kasa Profili	Profil Kodu Profile Code	(kg/mt) Weight
FRAME PROFILE	478	0,770

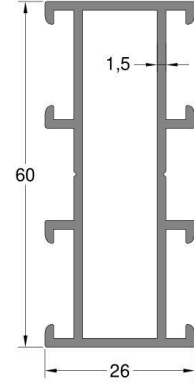

Dar Kasa Profili	Profil Kodu Profile Code	(kg/mt) Weight
FRAME PROFILE	530	0,826

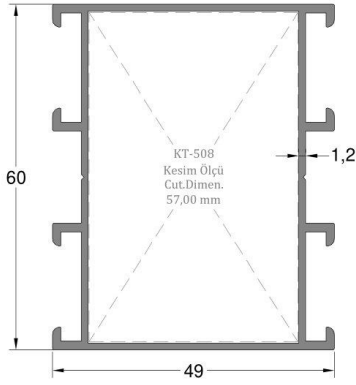

Kasa Profili	Profil Kodu Profile Code	(kg/mt) Weight
FRAME PROFILE	569	0,861

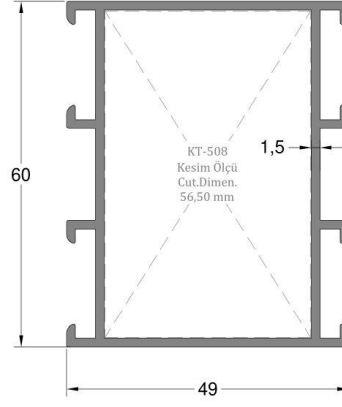

Kasa Profili	Profil Kodu Profile Code	(kg/mt) Weight
FRAME PROFILE	452	1,013

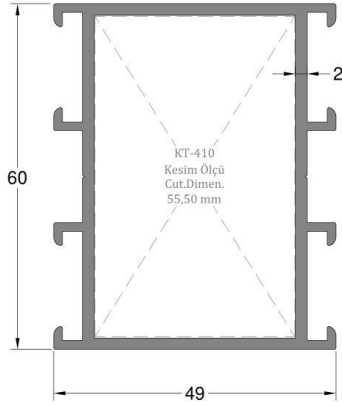

Kasa Profili	Profil Kodu Profile Code	(kg/mt) Weight
FRAME PROFILE	2021	1,264

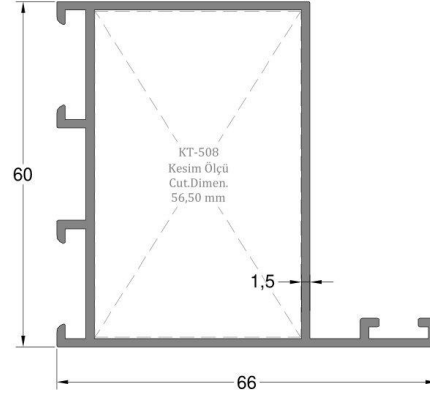

Kasa Profili	Profil Kodu Profile Code	(kg/mt) Weight
FRAME PROFILE	522	1,029

** Her profil için minimum sipariş 300 kg'dır.
** Minimum order quantity is 300 kg per profile.

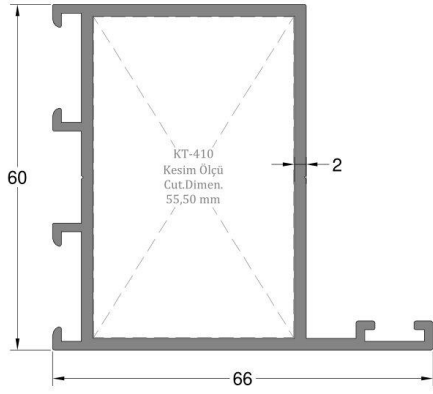

Kasa Profili	Profil Kodu	(kg/mt)
FRAME PROFILE	Profile Code	Weight
	521	1,290

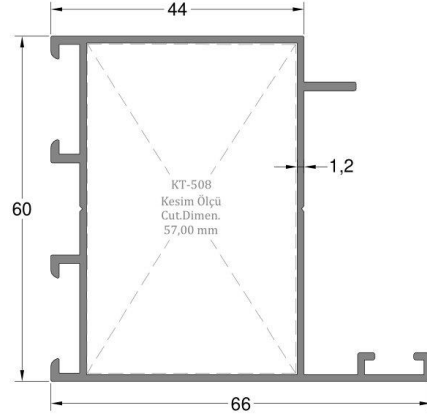

Kanat Profili	Profil Kodu	(kg/mt)
SASH PROFILE	Profile Code	Weight
	6080	0,888

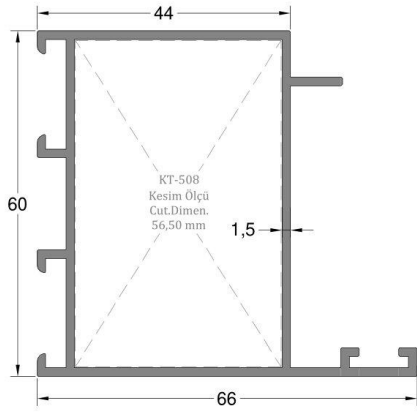

Kanat Profili	Profil Kodu	(kg/mt)
SASH PROFILE	Profile Code	Weight
	451	1,064

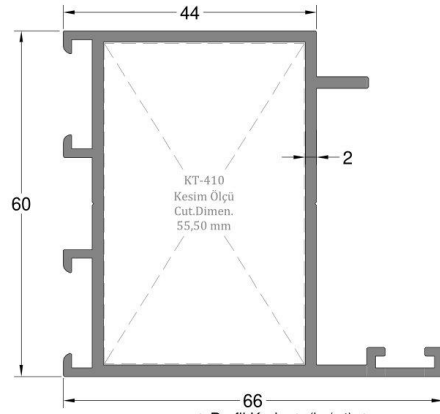

Kanat Profili	Profil Kodu	(kg/mt)
SASH PROFILE	Profile Code	Weight
	2020	1,339

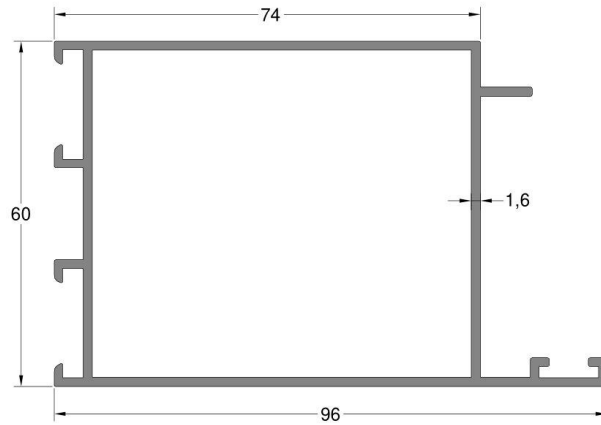

Geniş Kanat Profili	Profil Kodu	(kg/mt)
LARGE SASH PROFILE	Profile Code	Weight
	475	1,381

** Her profil için minimum sipariş 300 kg'dır.
** Minimum order quantity is 300 kg per profile.

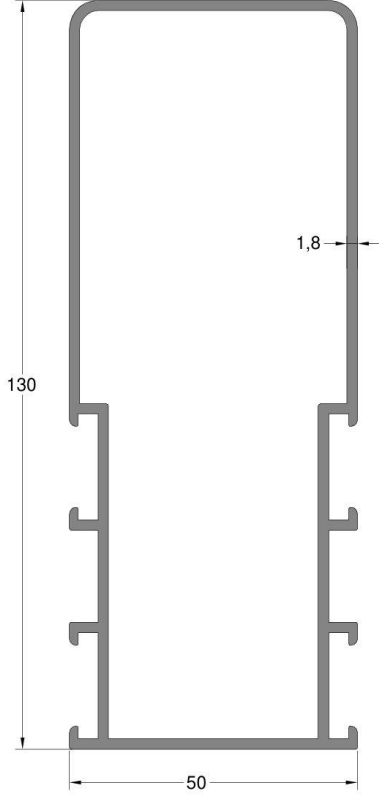

Takviyeli Kasa Profili	Profil Kodu	(kg/mt)
REINFORCED FRAME PROFILE	Profile Code	Weight
	705	1,914

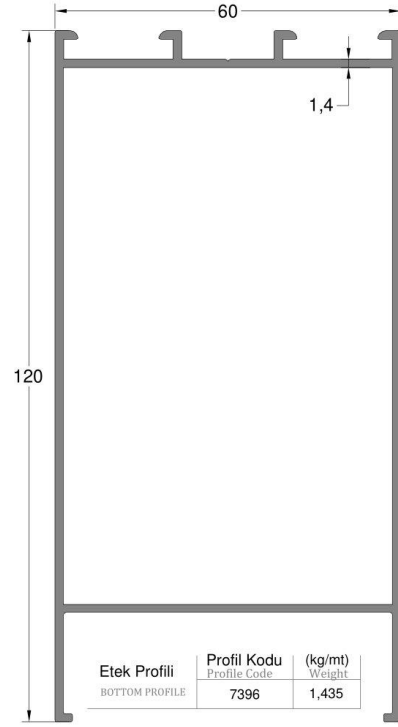

Etek Profili	Profil Kodu	(kg/mt)
BOTTOM PROFILE	Profile Code	Weight
	7396	1,435

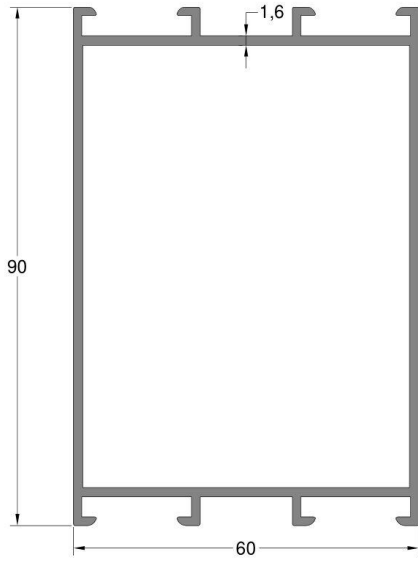

Geniş Kasa-Kanat Profili	Profil Kodu	(kg/mt)
LARGE FRAME-SASH PROFILE	Profile Code	Weight
	457	1,419

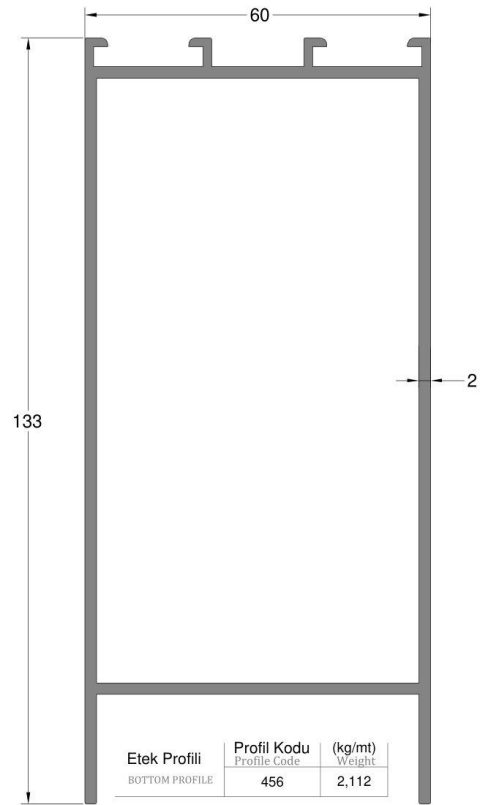

Etek Profili	Profil Kodu	(kg/mt)
BOTTOM PROFILE	Profile Code	Weight
	456	2,112

** Her profil için minimum sipariş 300 kg'dır.
** Minimum order quantity is 300 kg per profile.

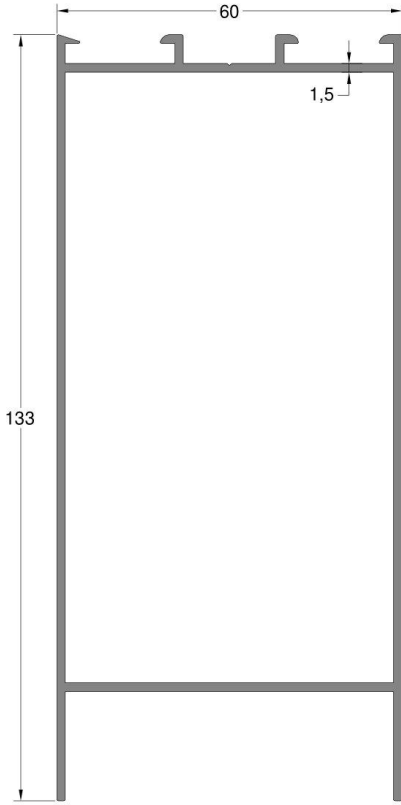

Etek Profili	Profil Kodu	(kg/mt)
BOTTOM PROFILE	Profile Code	Weight
	518	1,621

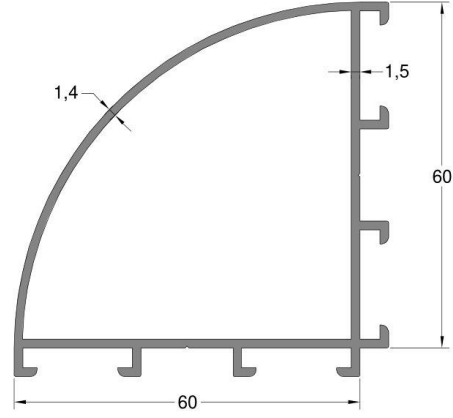

Köşe Dönüş Profili	Profil Kodu	(kg/mt)
CORNER PROFILE	Profile Code	Weight
	453	1,059

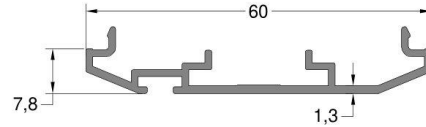

Adaptör Profili	Profil Kodu	(kg/mt)
ADAPTER PROFILE	Profile Code	Weight
	700	0,370

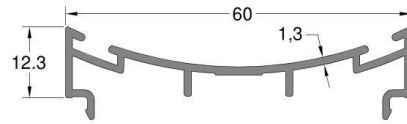

Adaptör Profili	Profil Kodu	(kg/mt)
ADAPTER PROFILE	Profile Code	Weight
	704	0,410

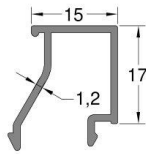

Çıta Profili	Profil Kodu	(kg/mt)
BEAD PROFILE	Profile Code	Weight
	6975	0,203

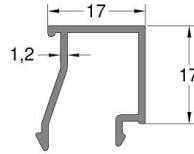

Çıta Profili	Profil Kodu	(kg/mt)
BEAD PROFILE	Profile Code	Weight
	455	0,207

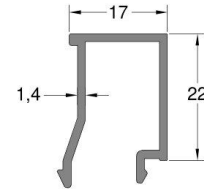

Çıta Profili	Profil Kodu	(kg/mt)
BEAD PROFILE	Profile Code	Weight
	2023	0,277

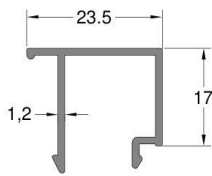

Çıta Profili	Profil Kodu	(kg/mt)
BEAD PROFILE	Profile Code	Weight
	454	0,228

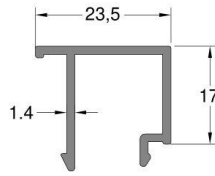

Çıta Profili	Profil Kodu	(kg/mt)
BEAD PROFILE	Profile Code	Weight
	2022	0,262

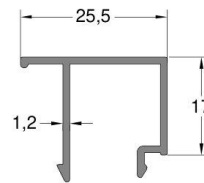

Çıta Profili	Profil Kodu	(kg/mt)
BEAD PROFILE	Profile Code	Weight
	2279	0,236

** Her profil için minimum sipariş 300 kg'dır.
** Minimum order quantity is 300 kg per profile.

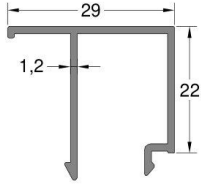

Çıta Profili	Profil Kodu	(kg/mt)
BEAD PROFILE	Profile Code	Weight
	509	0,277

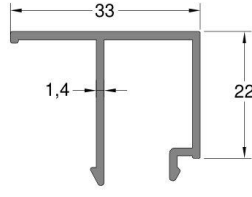

Çıta Profili	Profil Kodu	(kg/mt)
BEAD PROFILE	Profile Code	Weight
	2273	0,336

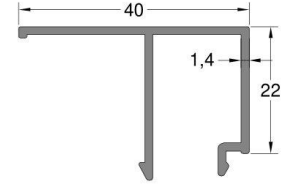

Çıta Profili	Profil Kodu	(kg/mt)
BEAD PROFILE	Profile Code	Weight
	5786	0,363

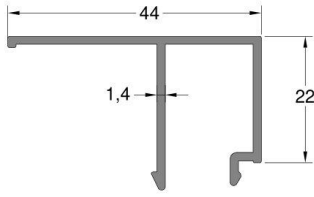

Çıta Profili	Profil Kodu	(kg/mt)
BEAD PROFILE	Profile Code	Weight
	2281	0,363

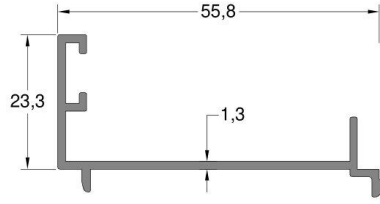

Adaptör Profili	Profil Kodu	(kg/mt)
ADAPTER PROFILE	Profile Code	Weight
	701	0,380

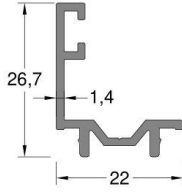

Adaptör Profili	Profil Kodu	(kg/mt)
ADAPTER PROFILE	Profile Code	Weight
	510	0,255

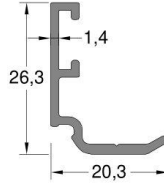

Adaptör Profili	Profil Kodu	(kg/mt)
ADAPTER PROFILE	Profile Code	Weight
	5601	0,216

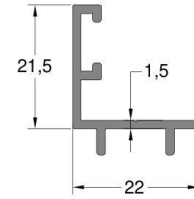

Ek Adaptör Profili	Profil Kodu	(kg/mt)
ADAPTER PROFILE	Profile Code	Weight
	2030	0,247

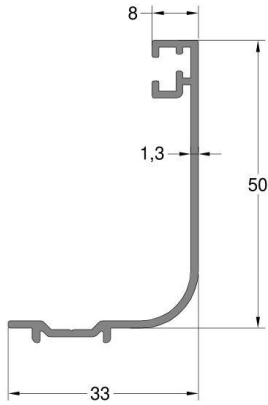

Ek Pervaz Profili	Profil Kodu	(kg/mt)
SILL PROFILE	Profile Code	Weight
	479	0,364

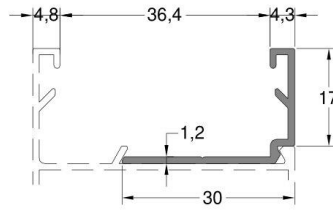

Kasa Adaptör Profili	Profil Kodu	(kg/mt)
FRAME ADAPTER PROFILE	Profile Code	Weight
	481	0,183

** Her profil için minimum sipariş 300 kg'dır.
** Minimum order quantity is 300 kg per profile.

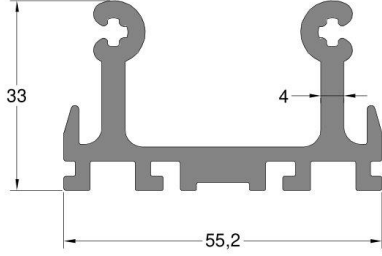

Dik Bağlantı Profili	Profil Kodu	(kg/mt)
CONNECTION PROFILE	Profile Code	Weight
	458	1,508

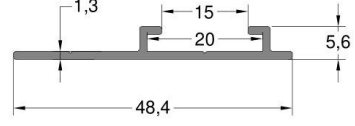

İspanyolet Profili	Profil Kodu	(kg/mt)
ESPAGNOLETTE PROFILE	Profile Code	Weight
	480	0,218

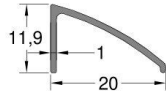

Damlalık Profili	Profil Kodu	(kg/mt)
SILL PROFILE	Profile Code	Weight
	4242	0,094

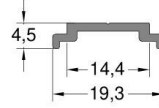

Tij Profili	Profil Kodu	(kg/mt)
STEM BAR PROFILE	Profile Code	Weight
	8241	0,099

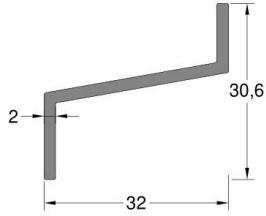

Menfez Profili	Profil Kodu	(kg/mt)
VENT PROFILE	Profile Code	Weight
	3840	0,299

** Her profil için minimum sipariş 300 kg'dır.
** Minimum order quantity is 300 kg per profile.

CAM ÇİTASI GLAZING BEAD (G)	CAM ÇİTASI UZUNLUĞU GLAZING BEAD LENGTH (L)	İÇ CAM FİTİLİ GLAZING GASKET (INSIDE) (I)	CAM KALINLIĞI GLASS THICKNESS (T)	DIŞ CAM FİTİLİ GLAZING GASKET (OUTSIDE) (O)
2273	33 mm	HCF.40	4 mm	SİLİKON
2281	44 mm	HCF.60	4 mm	SİLİKON
2022	23,5 mm	HCF.40	5 mm	HCF.40
454	23,5 mm	HCF.30	6 mm	SİLİKON
454	23,5 mm	HCF.40	12 mm	HCF.40
2273	33 mm	KF.30	16 mm	KF.30
455	17 mm	HCF.30	20 mm	HCF.30
2022	23,5 mm	KF.50	20 mm	KF.50
2279	25,5 mm	HCF.60	22 mm	HCF.30
454	23,5 mm	HCF.60	24 mm	KF.40
2023	17 mm	HCF.60	28 mm	KF.50
455	17 mm	HCF.60	28 mm	KF.50

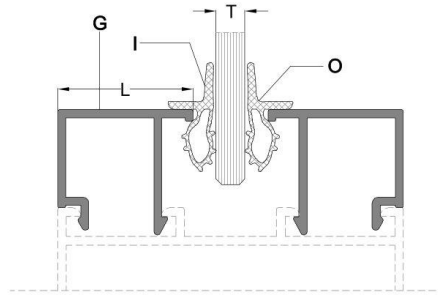

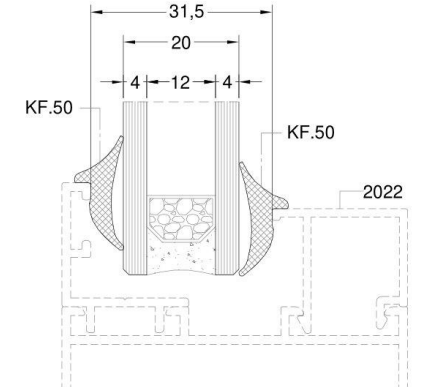
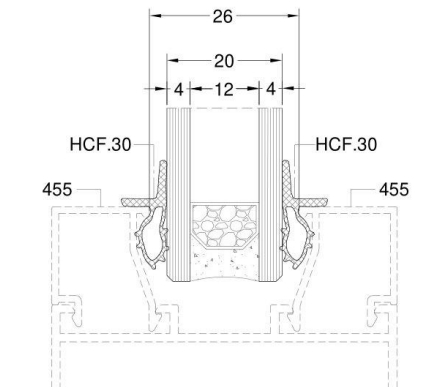
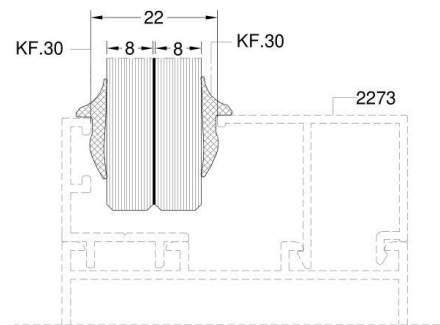
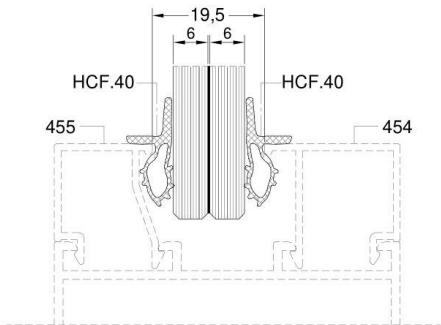
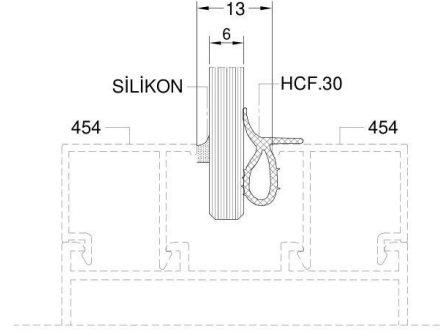
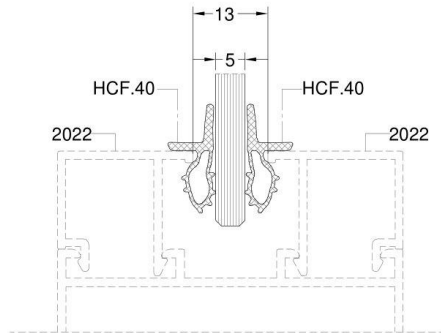
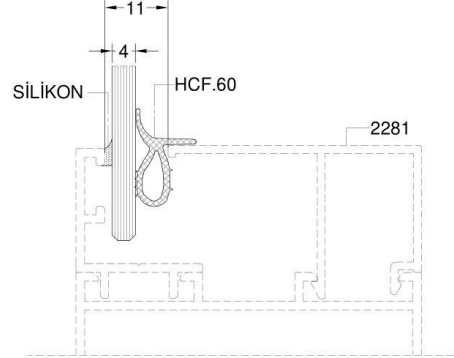
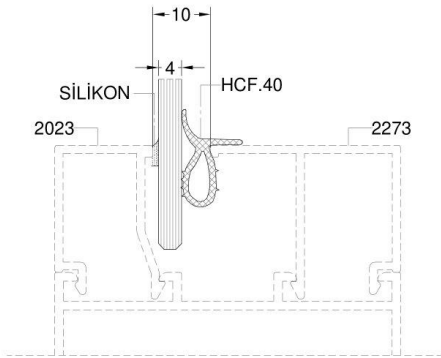

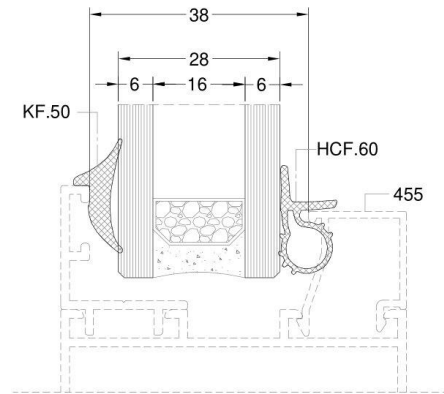
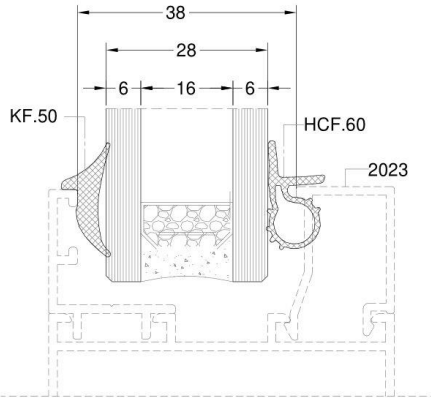
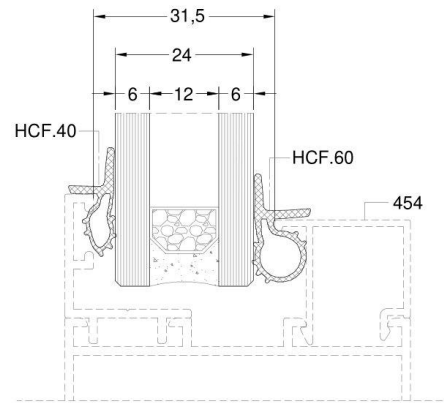
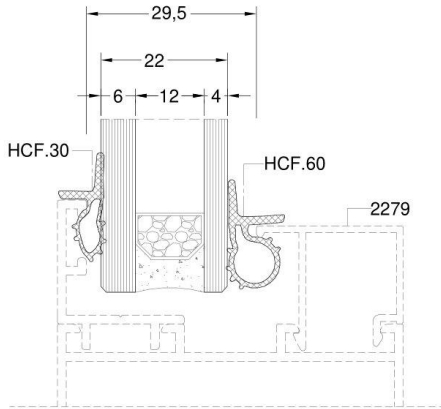

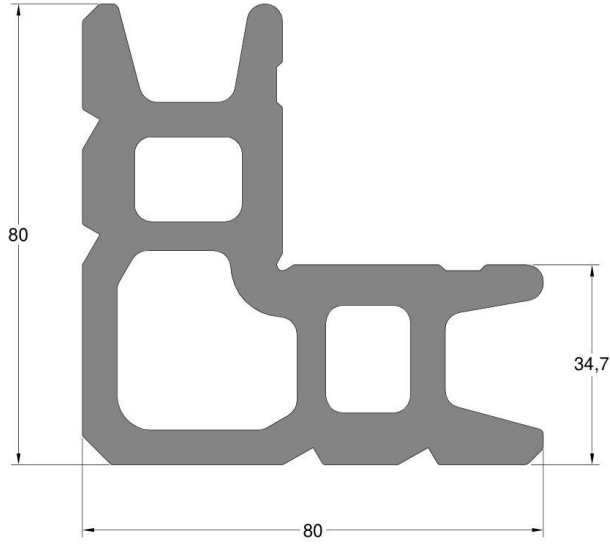

Köşe Takozu Profil Kodu Corner Wedge Profile Code	Kullanıldığı Profil Compatible Profile	Kesim Boyu (mm) Cutting Length (mm)
410	2021	55,5 mm
	521	55,5 mm
	2020	55,5 mm

Köşe Bağlantı Takoz Profili CORNER WEDGE PROFILE	Profil Kodu Profile Code	(kg/mt) Weight
	410	6,094

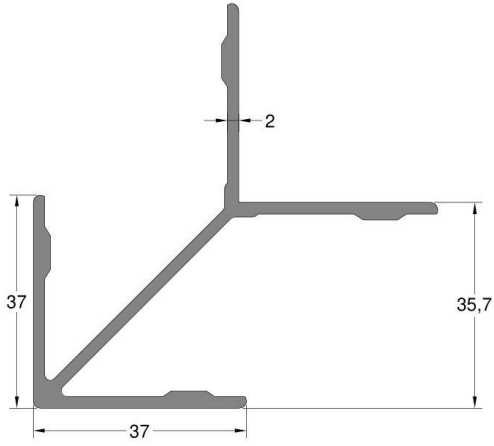

Köşe Takozu Profil Kodu Corner Wedge Profile Code	Kullanıldığı Profil Compatible Profile	Kesim Boyu (mm) Cutting Length (mm)
508	452	56,5 mm
	522	56,5 mm
	569	57 mm
	451	56,5 mm
	6080	57 mm

Köşe Çavuş Bağlantı Profili CORNER JOINT PROFILE	Profil Kodu Profile Code	(kg/mt) Weight
	508	1,112

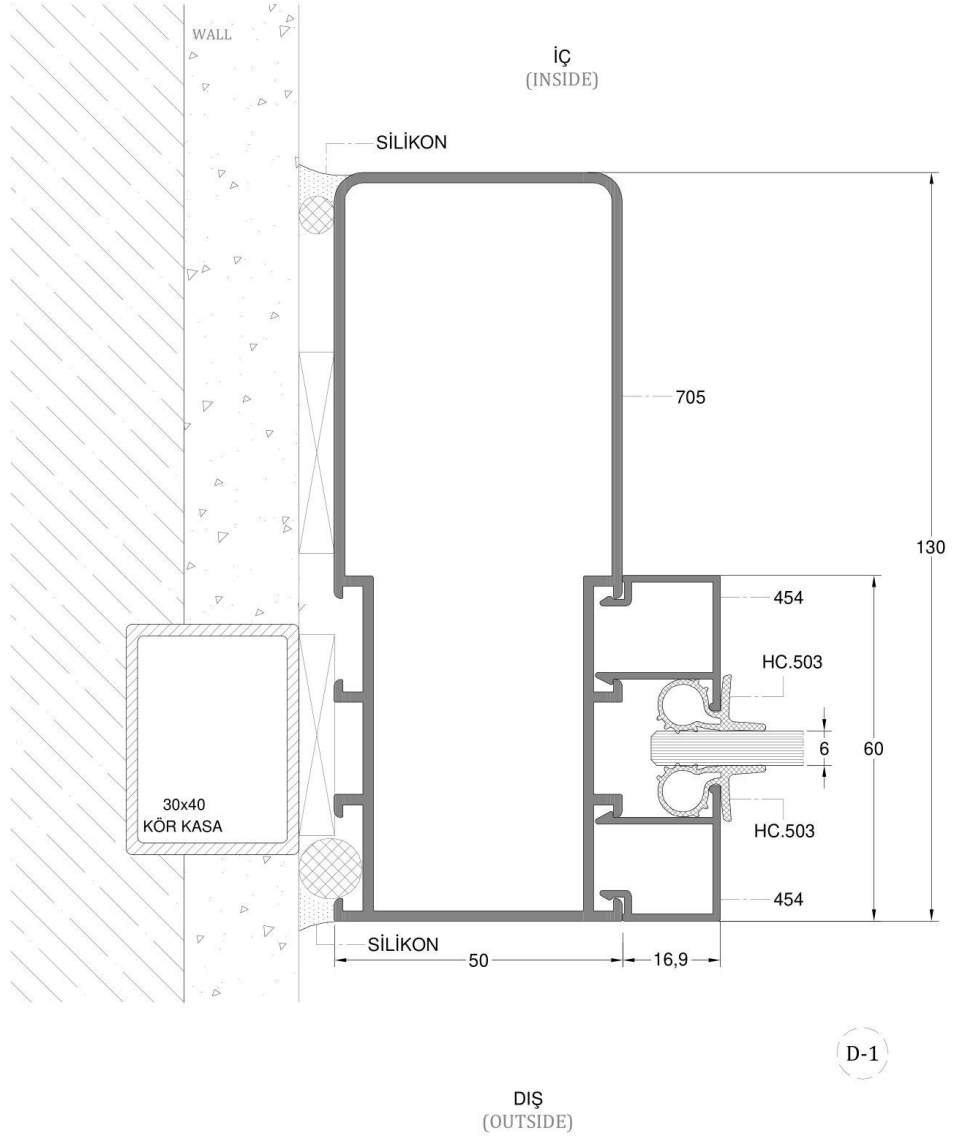
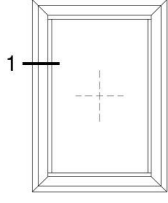

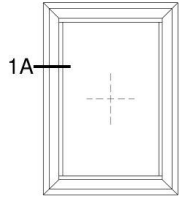

İÇ
(INSIDE)

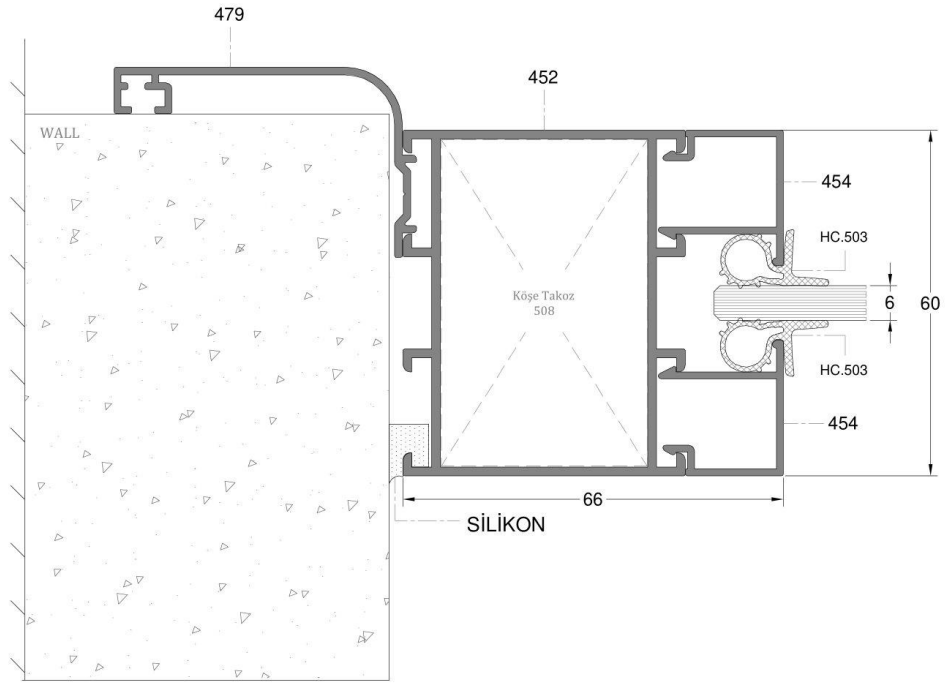

DIŞ
(OUTSIDE)

D-1A

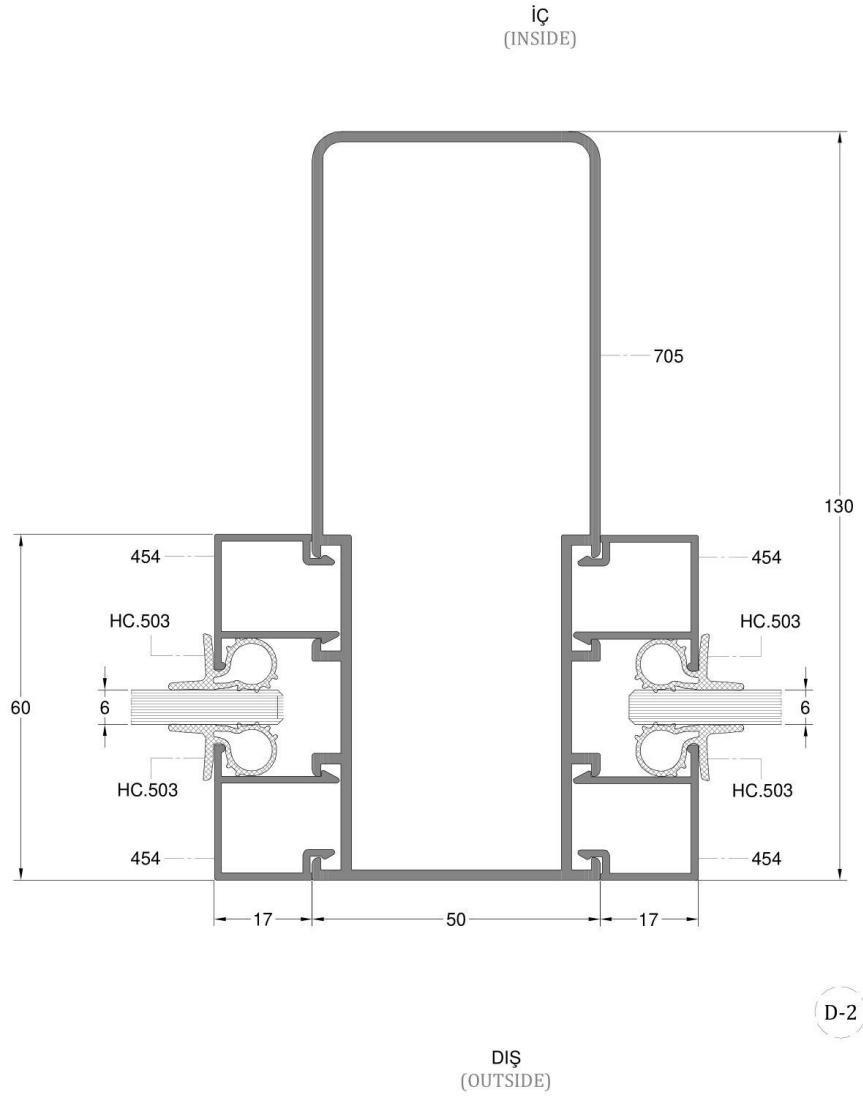
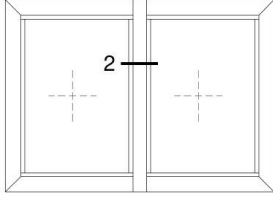

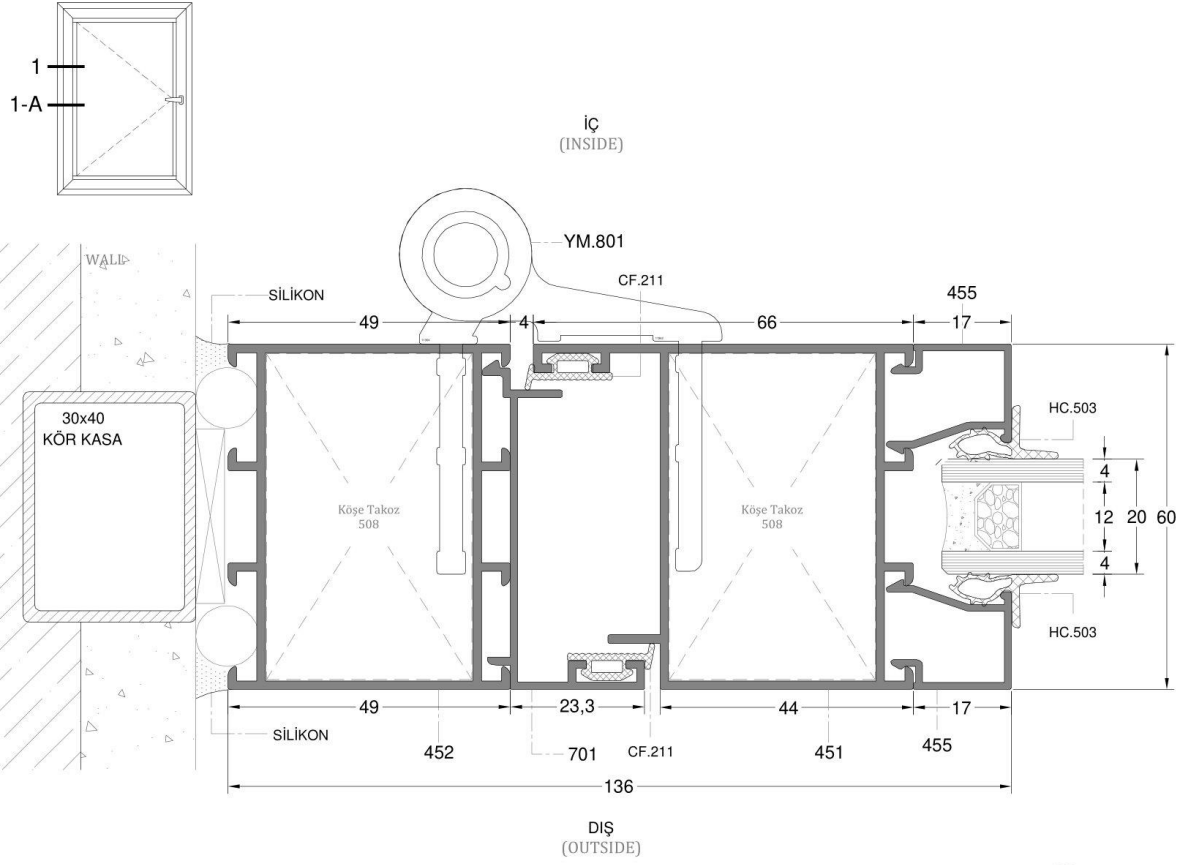

D-1

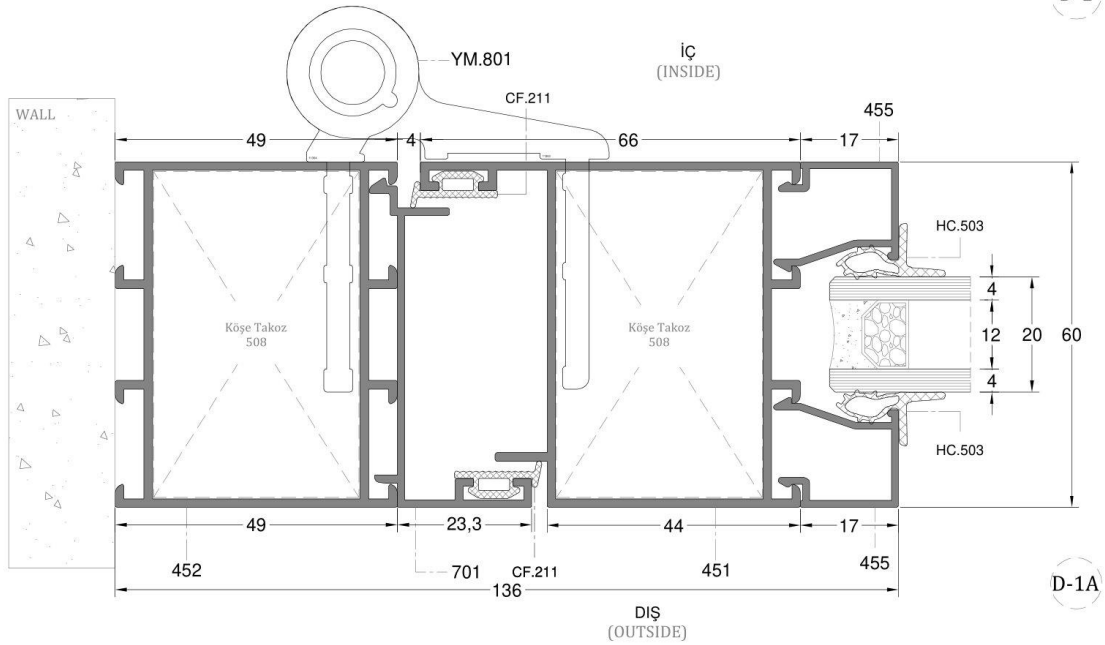

D-1A

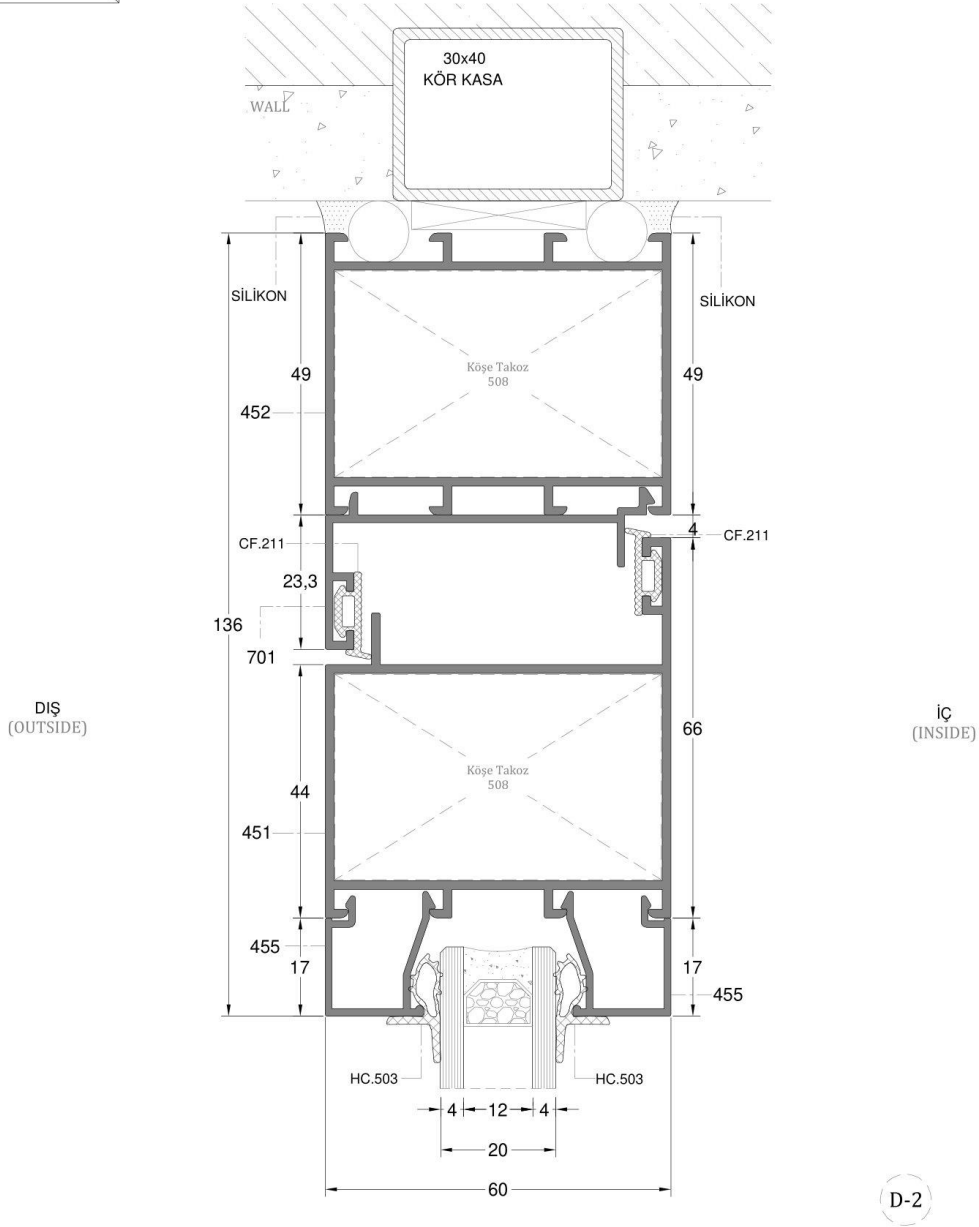
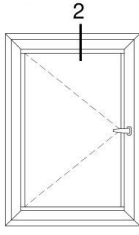

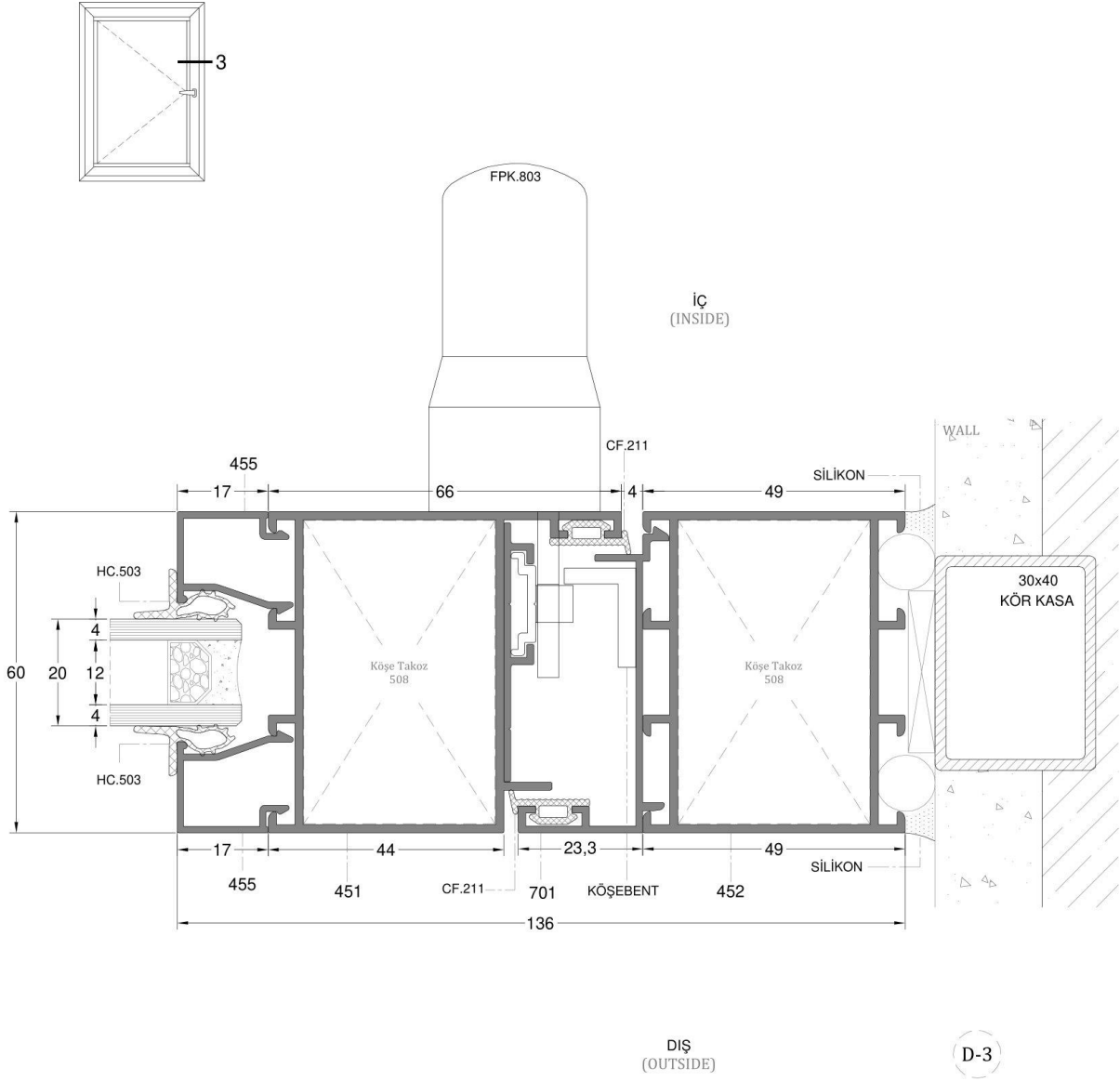

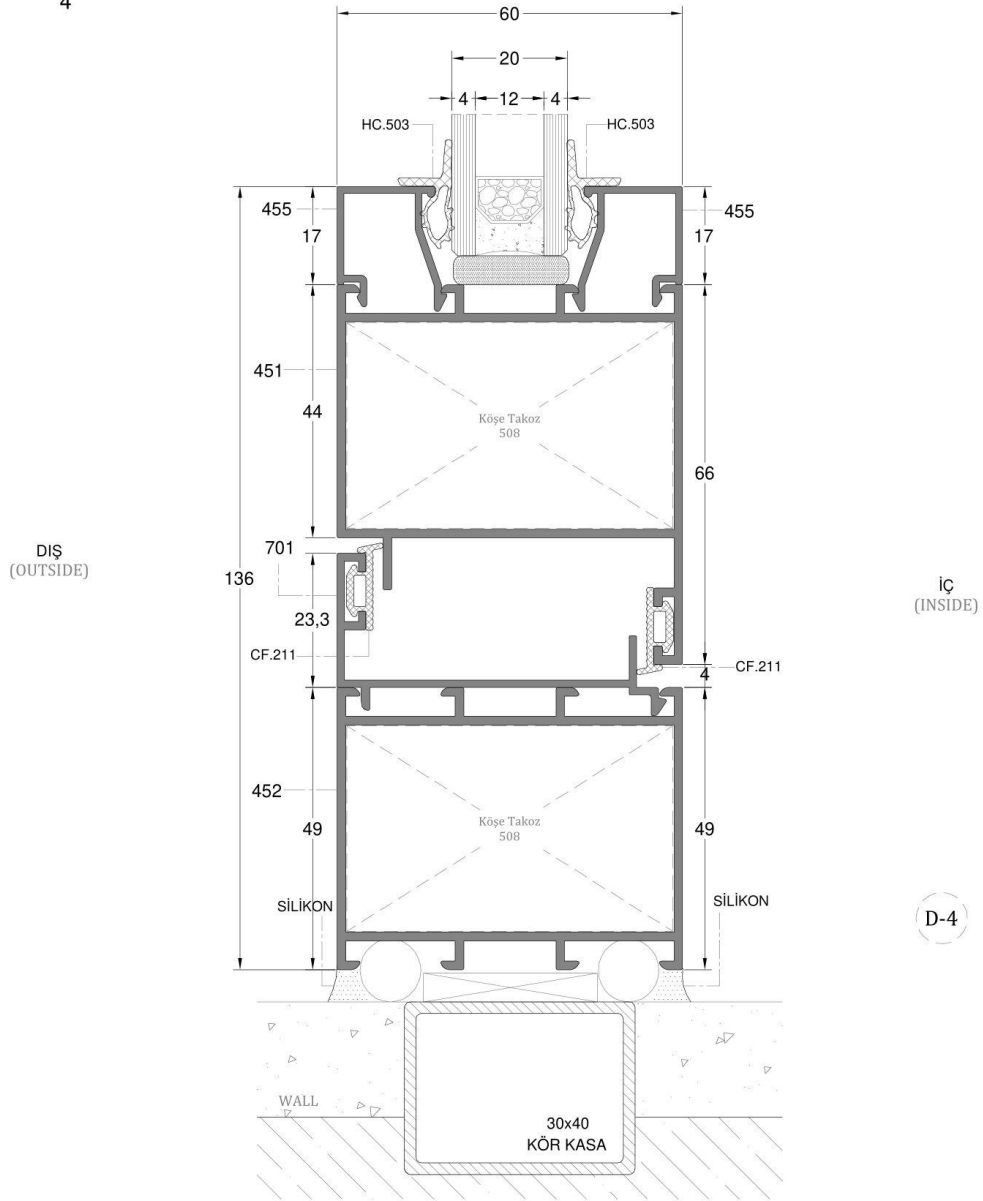
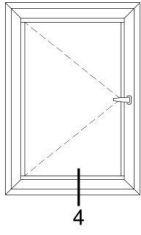

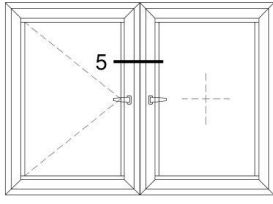

İÇ
(INSIDE)

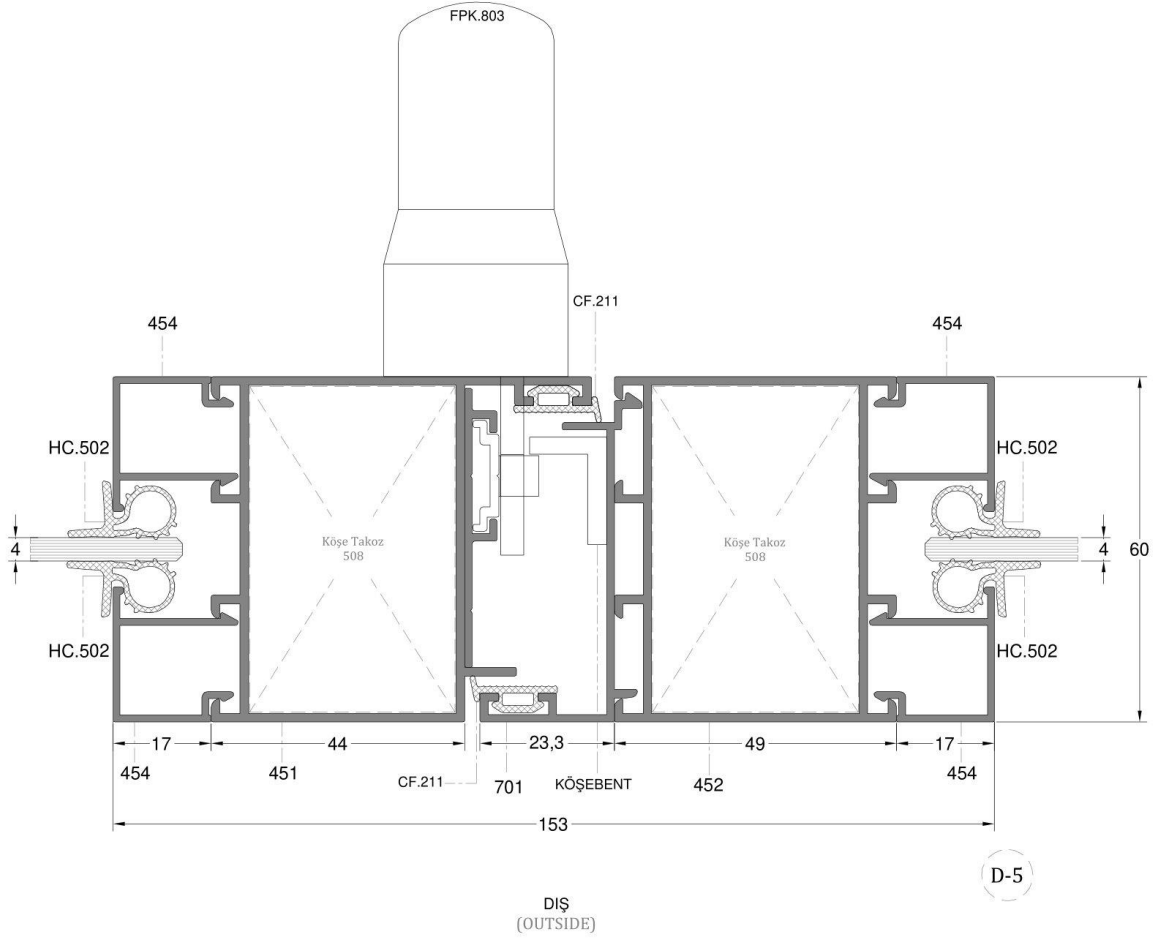

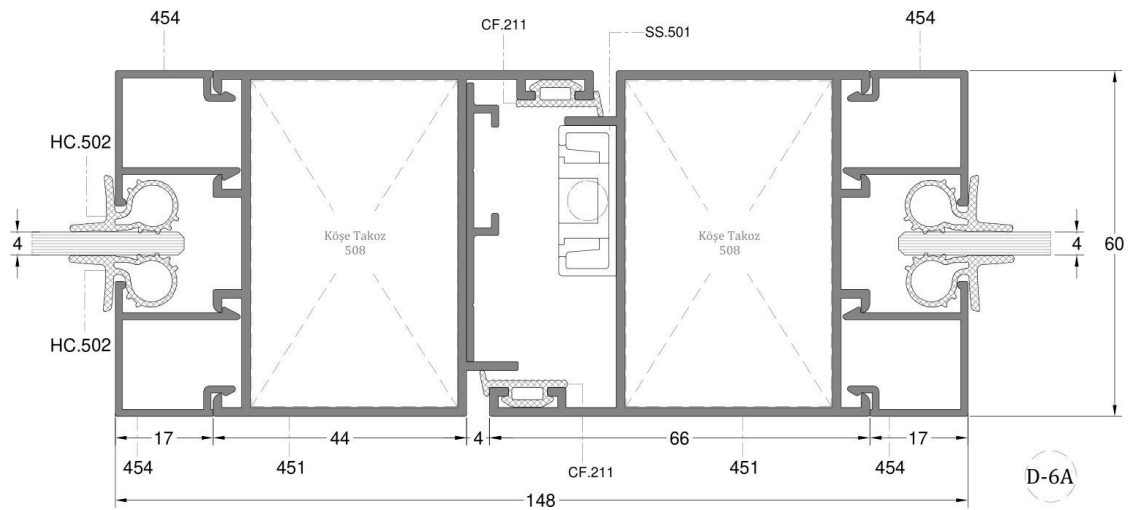
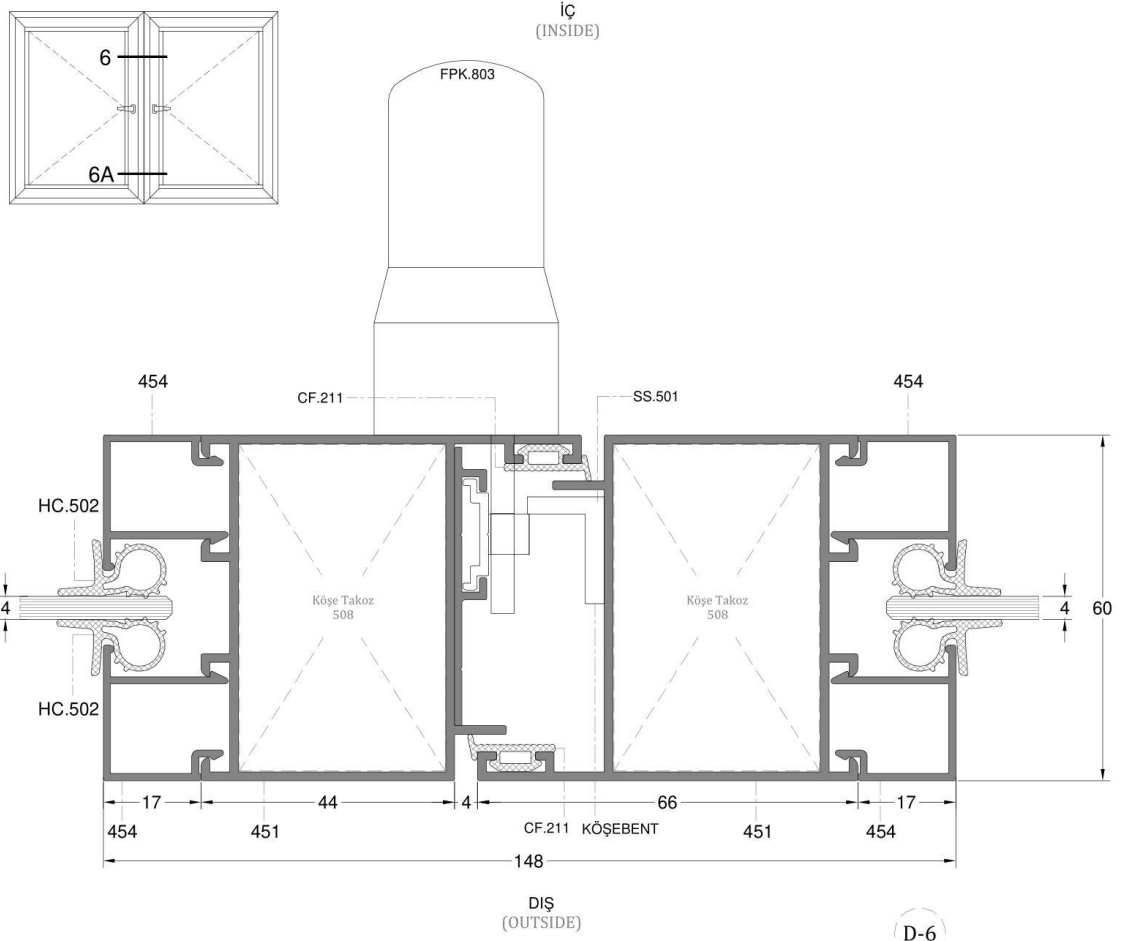

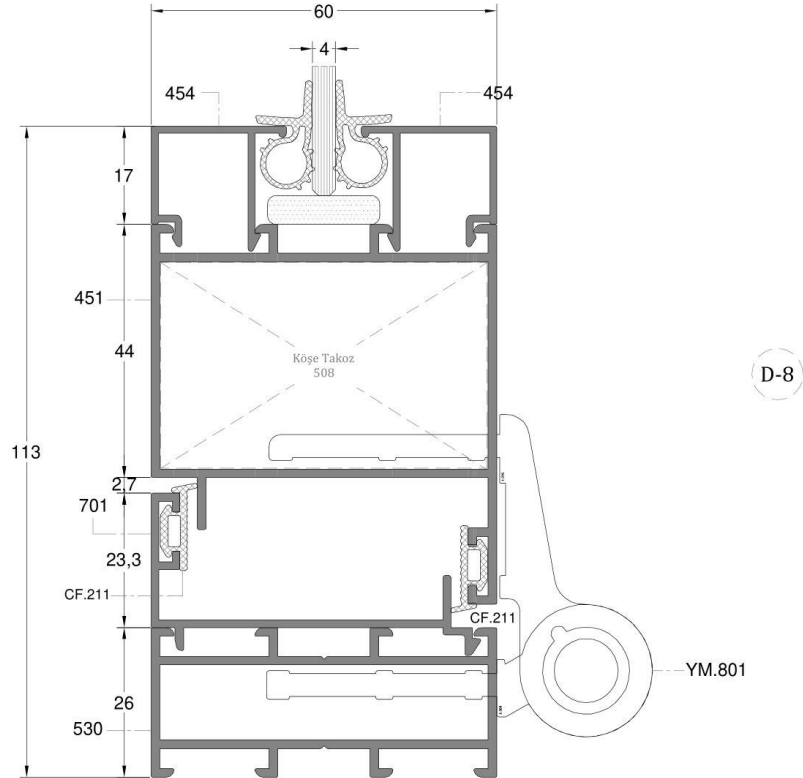
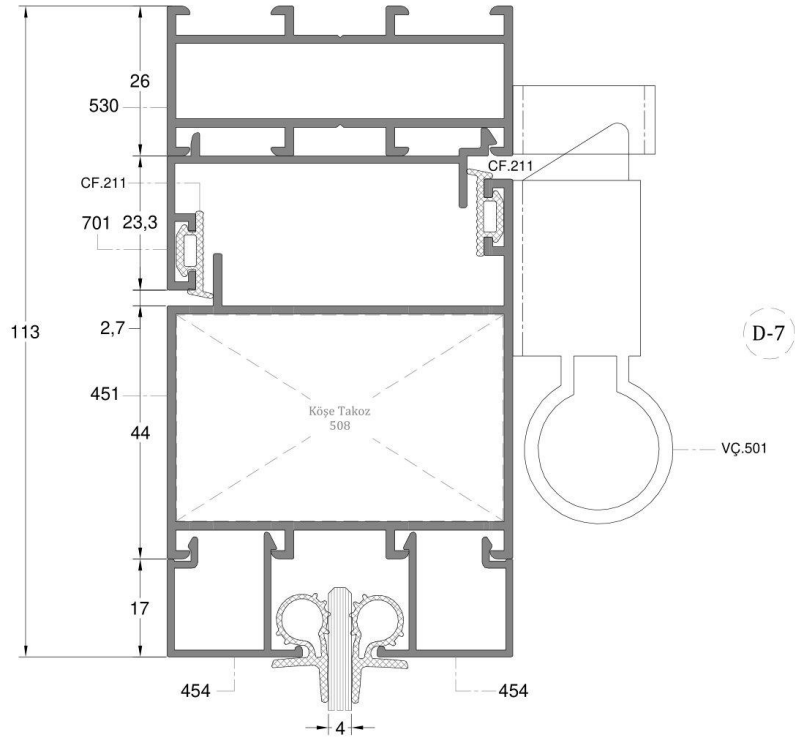
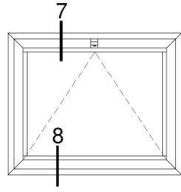

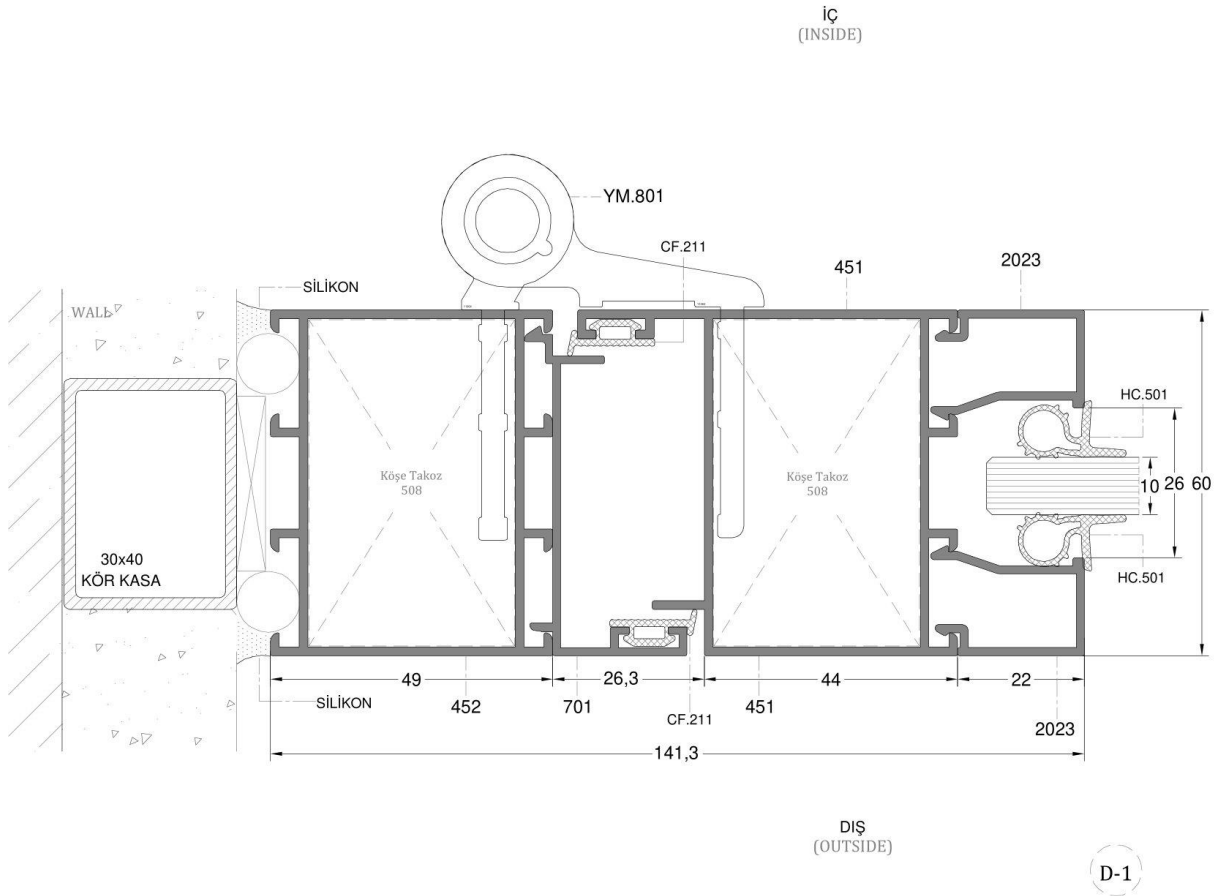
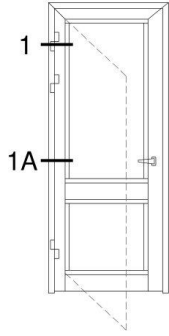

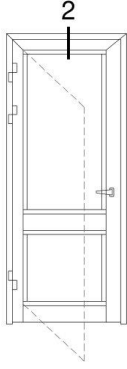

DIŞ
(OUTSIDE)

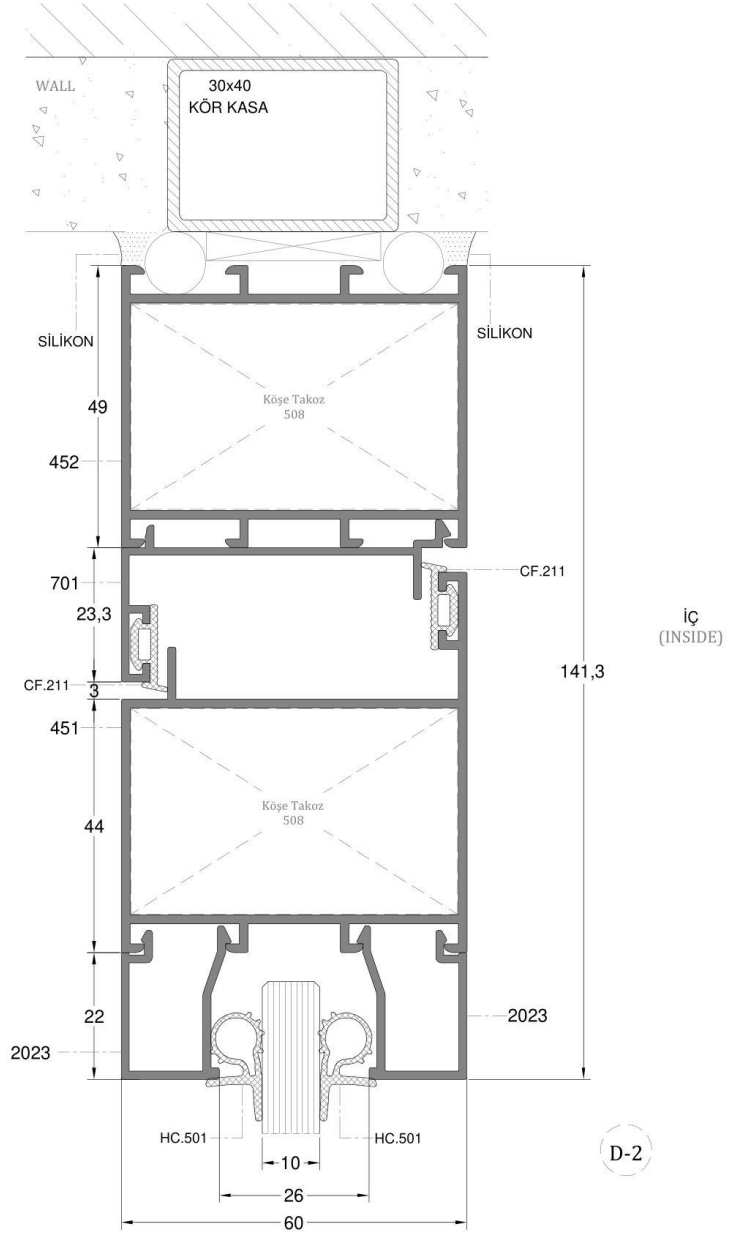

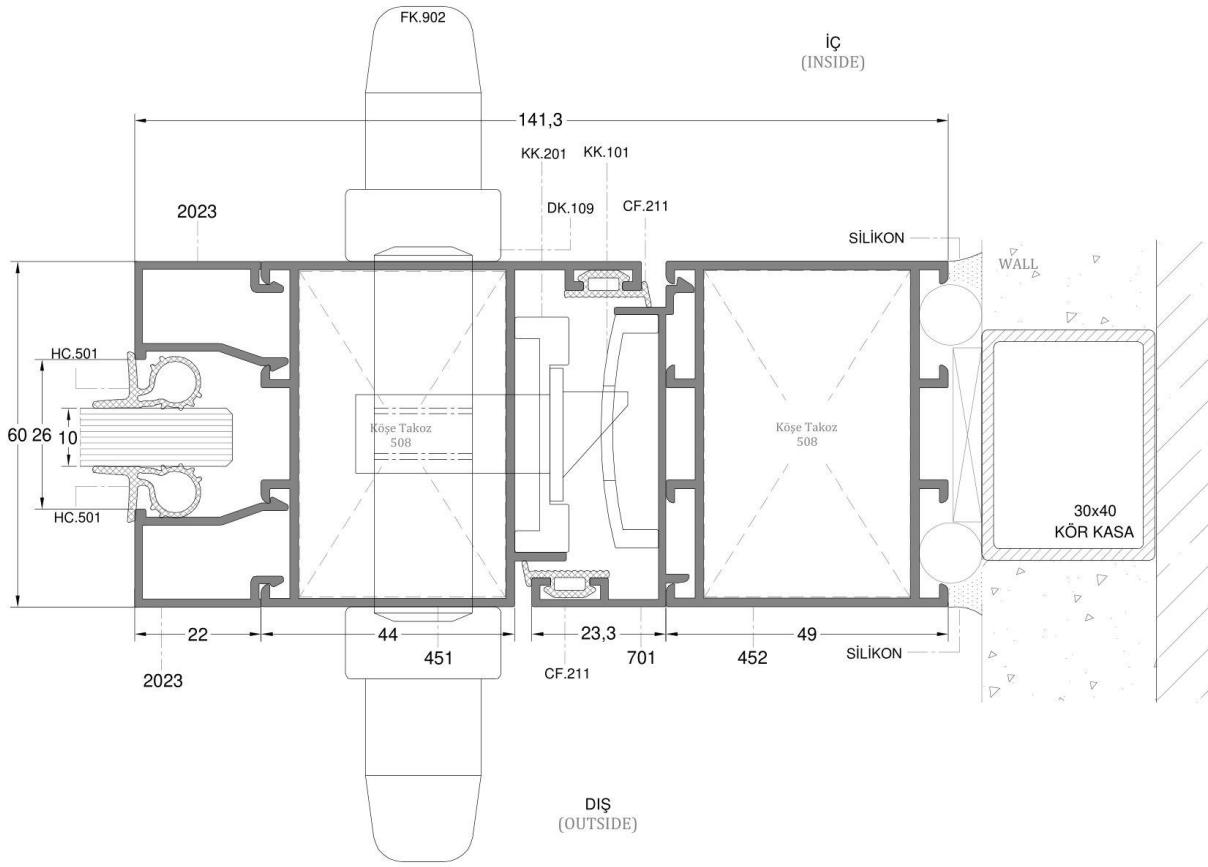
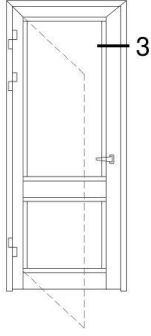

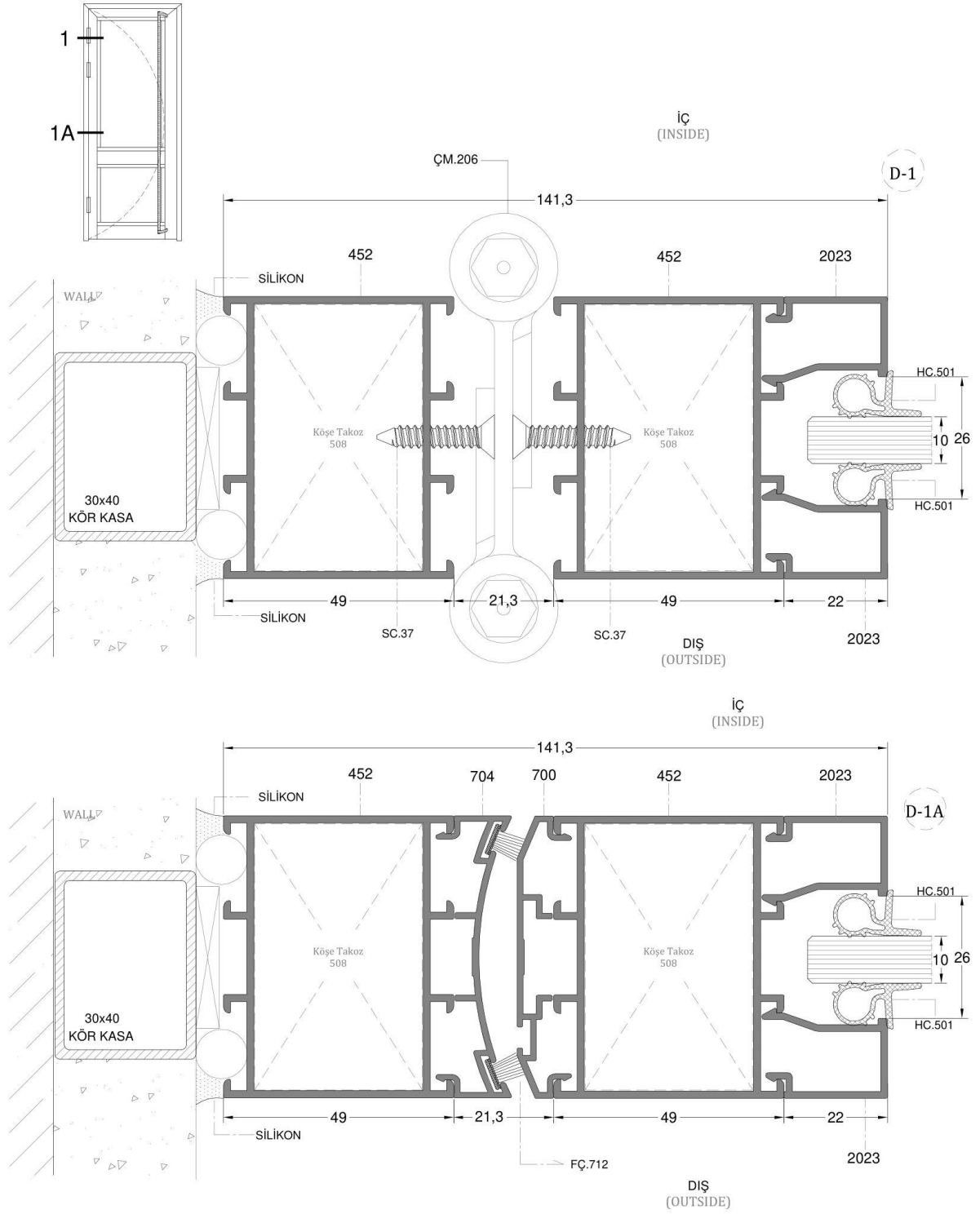

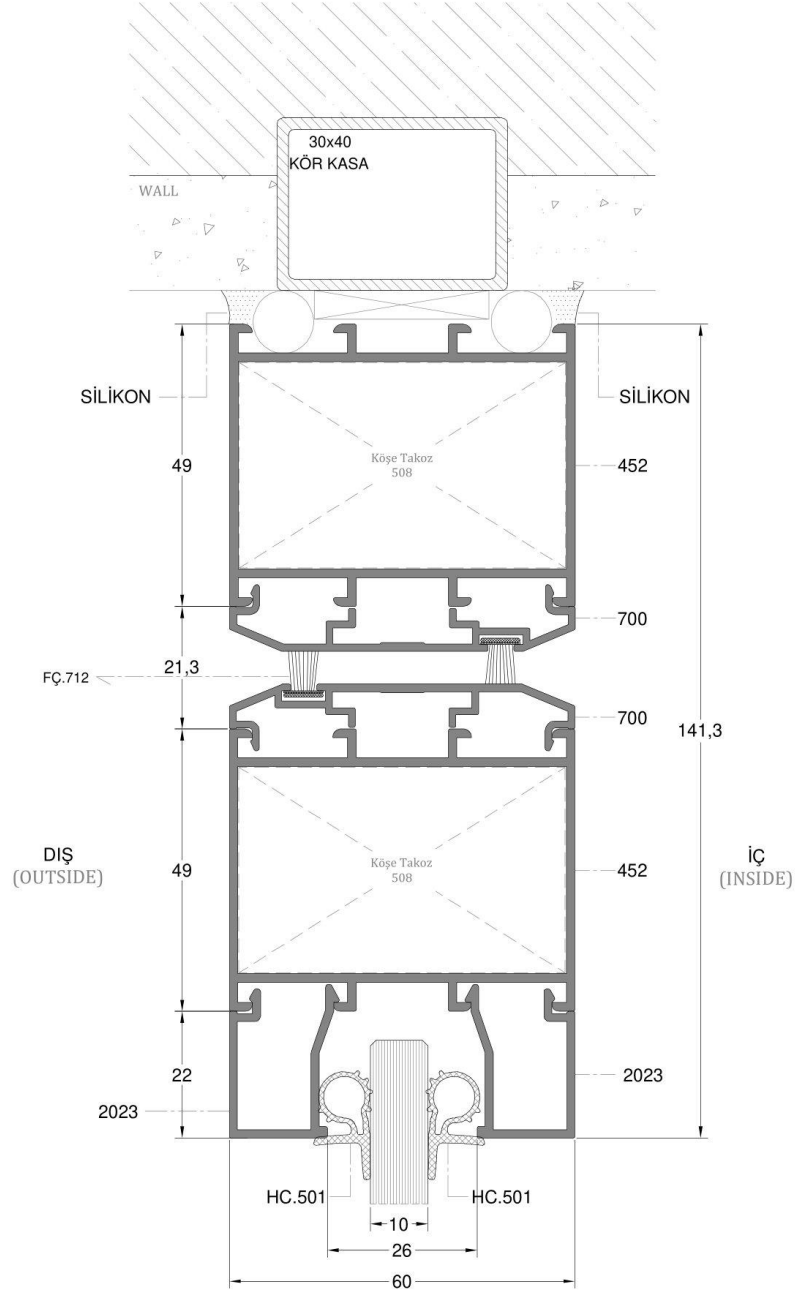
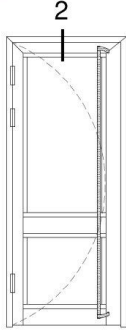

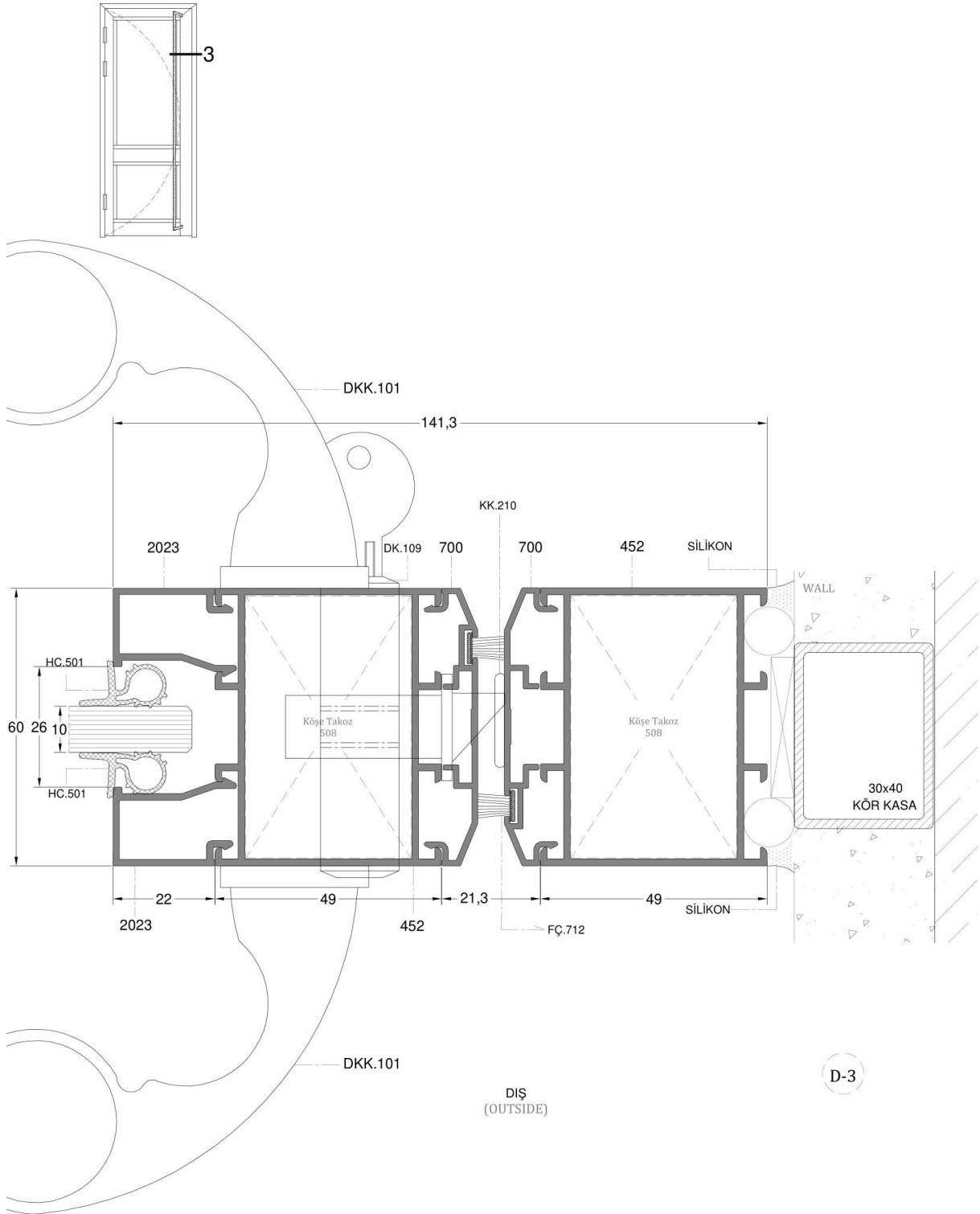

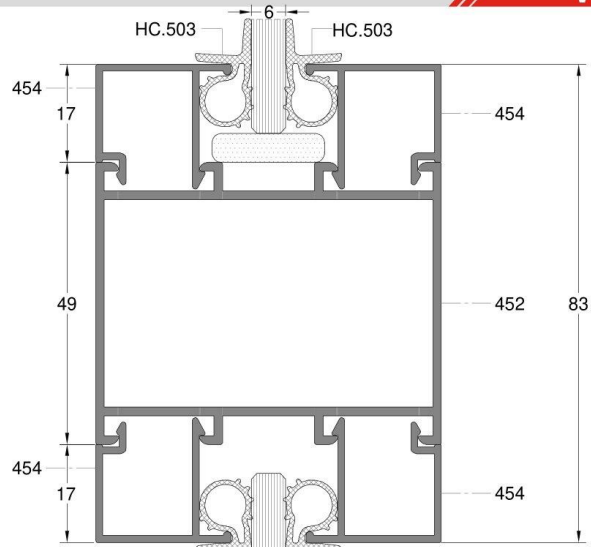
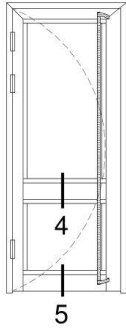

D-4

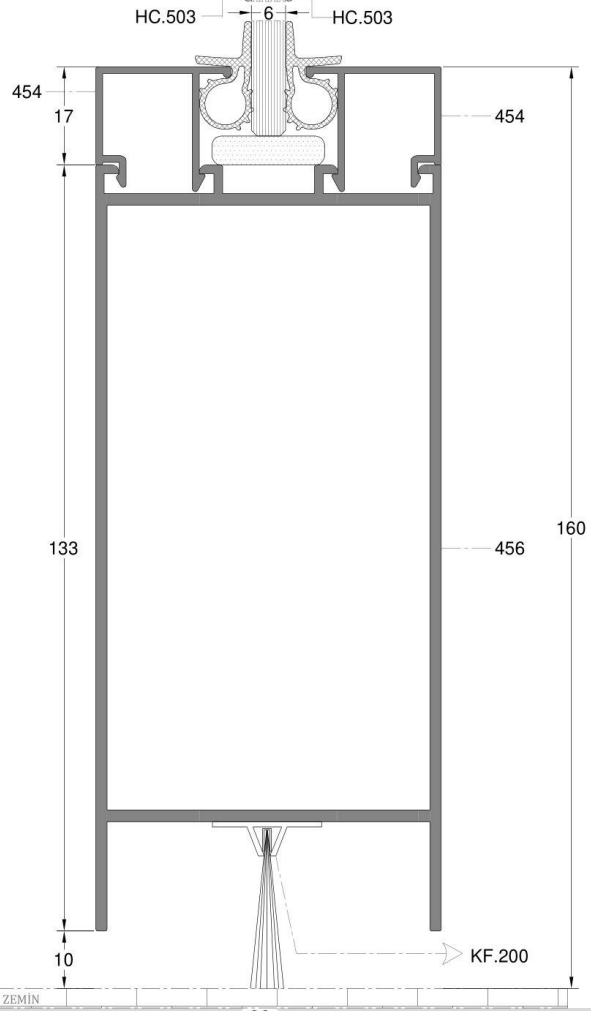

D-5

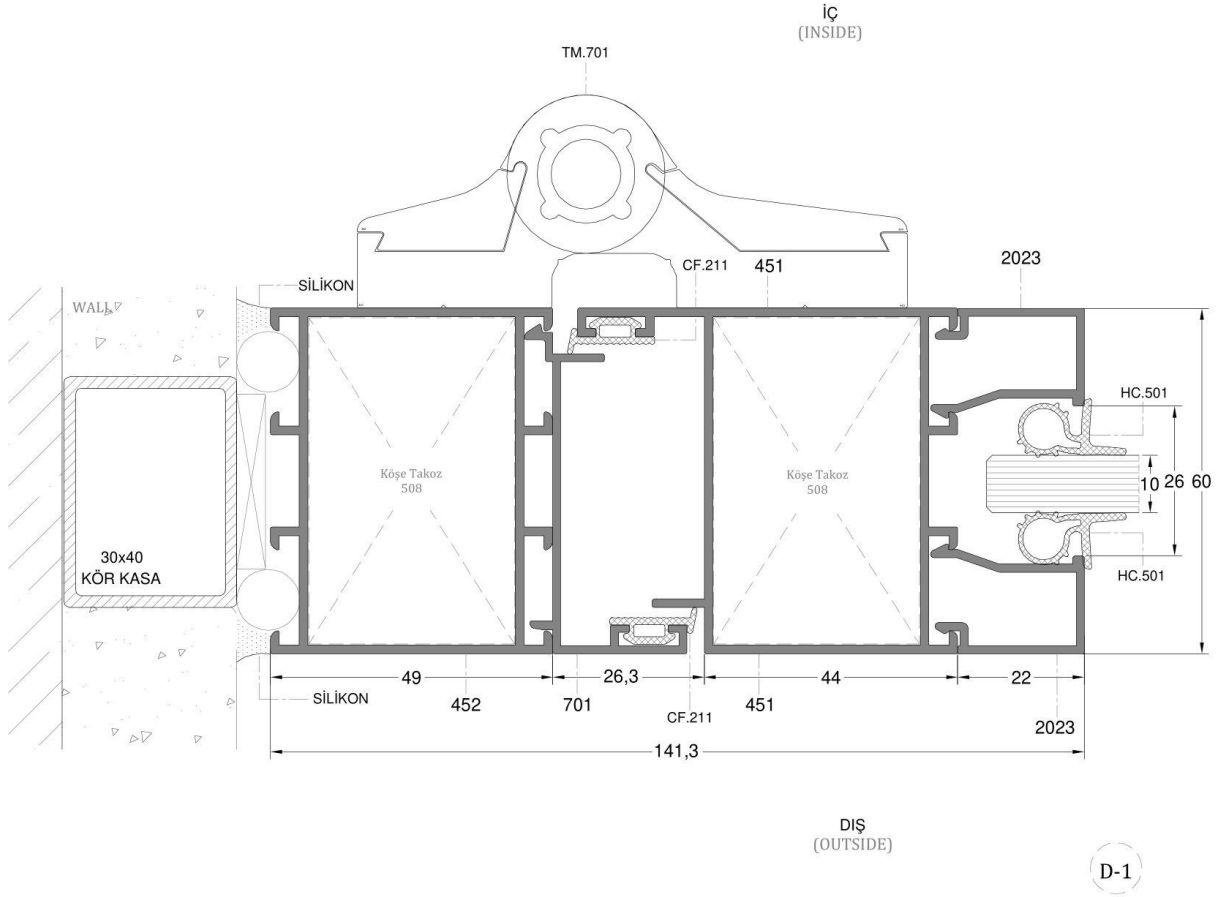
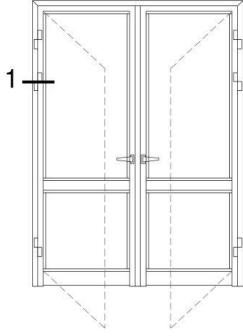

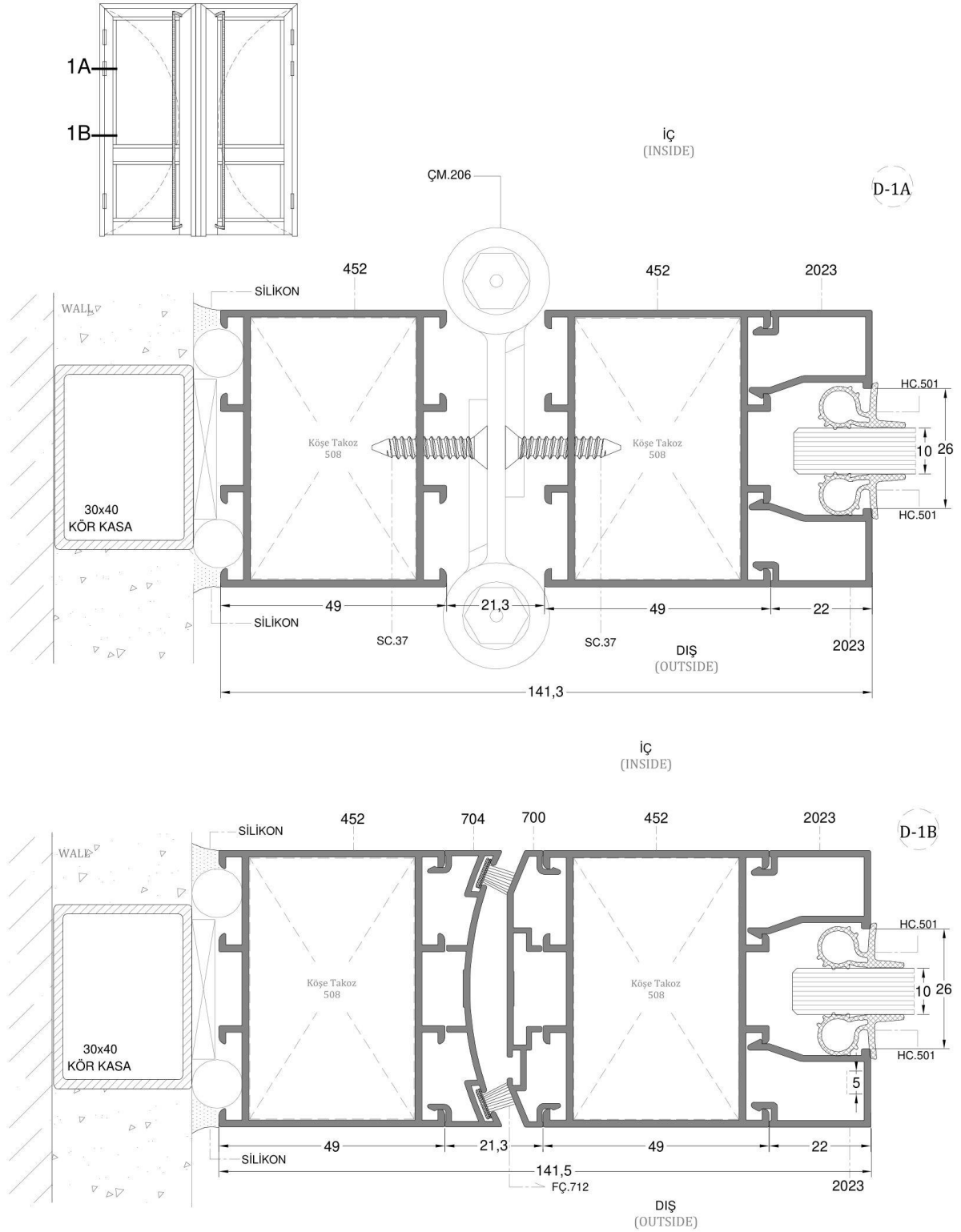

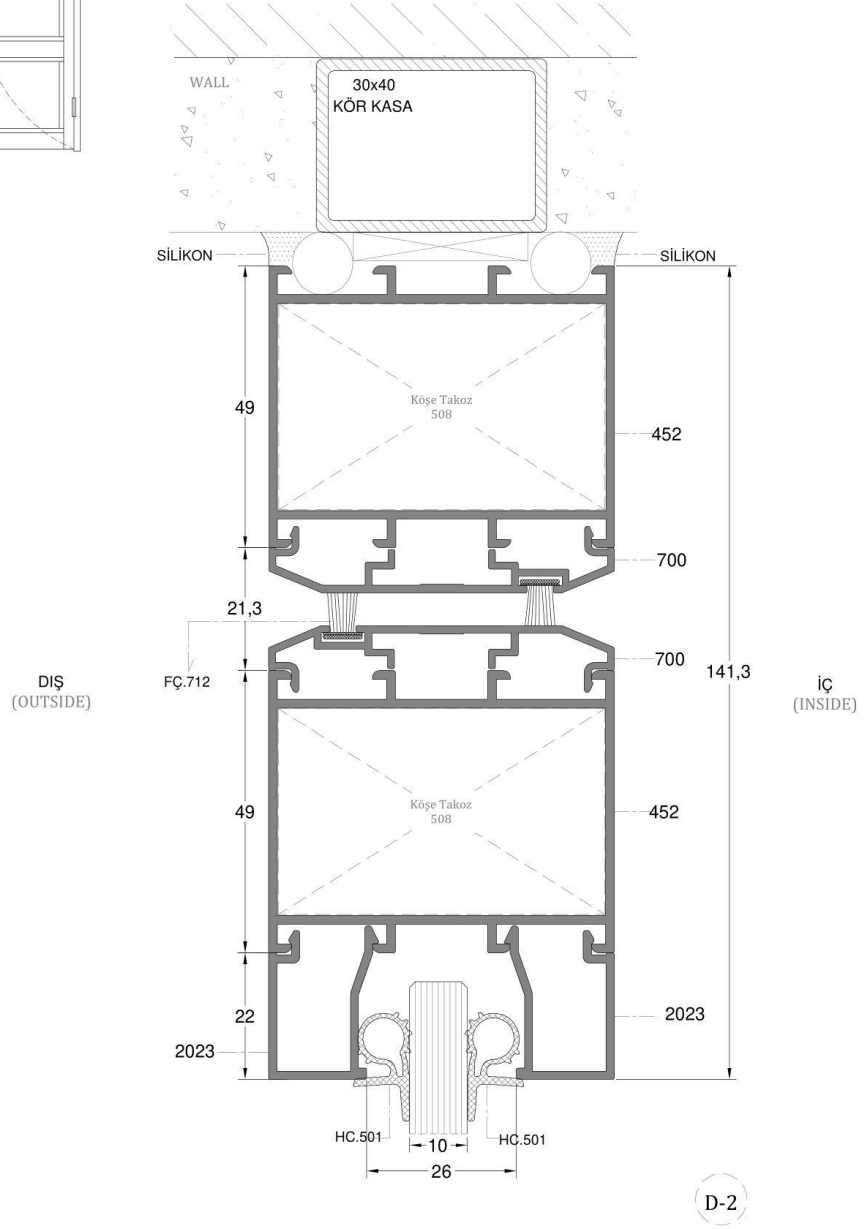
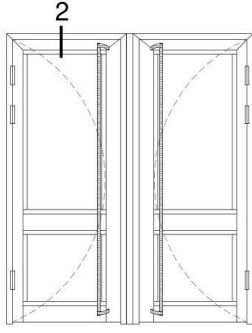

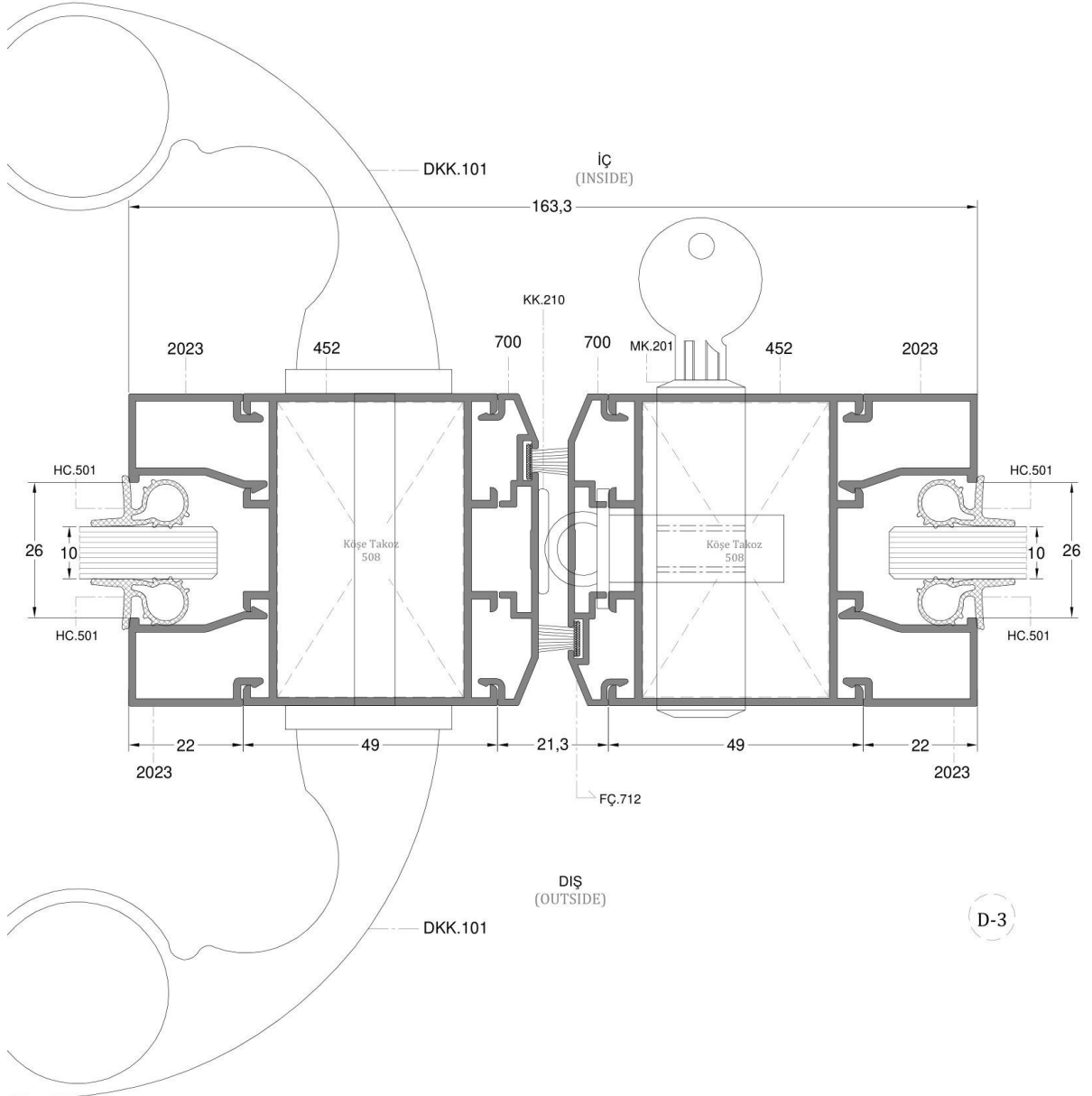
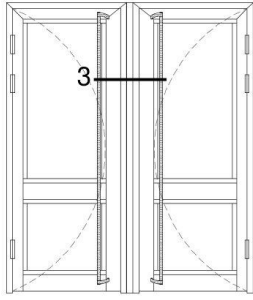

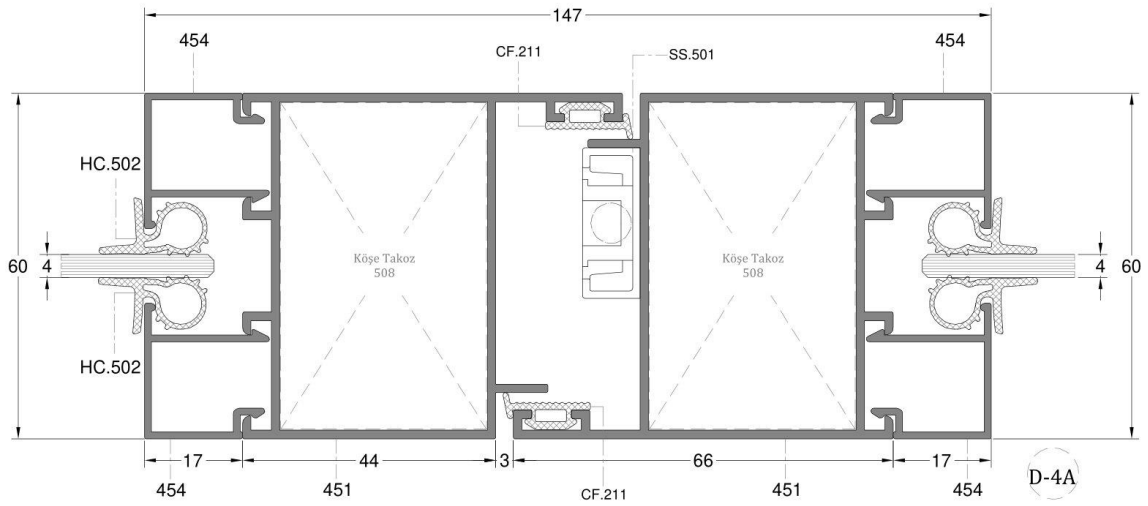
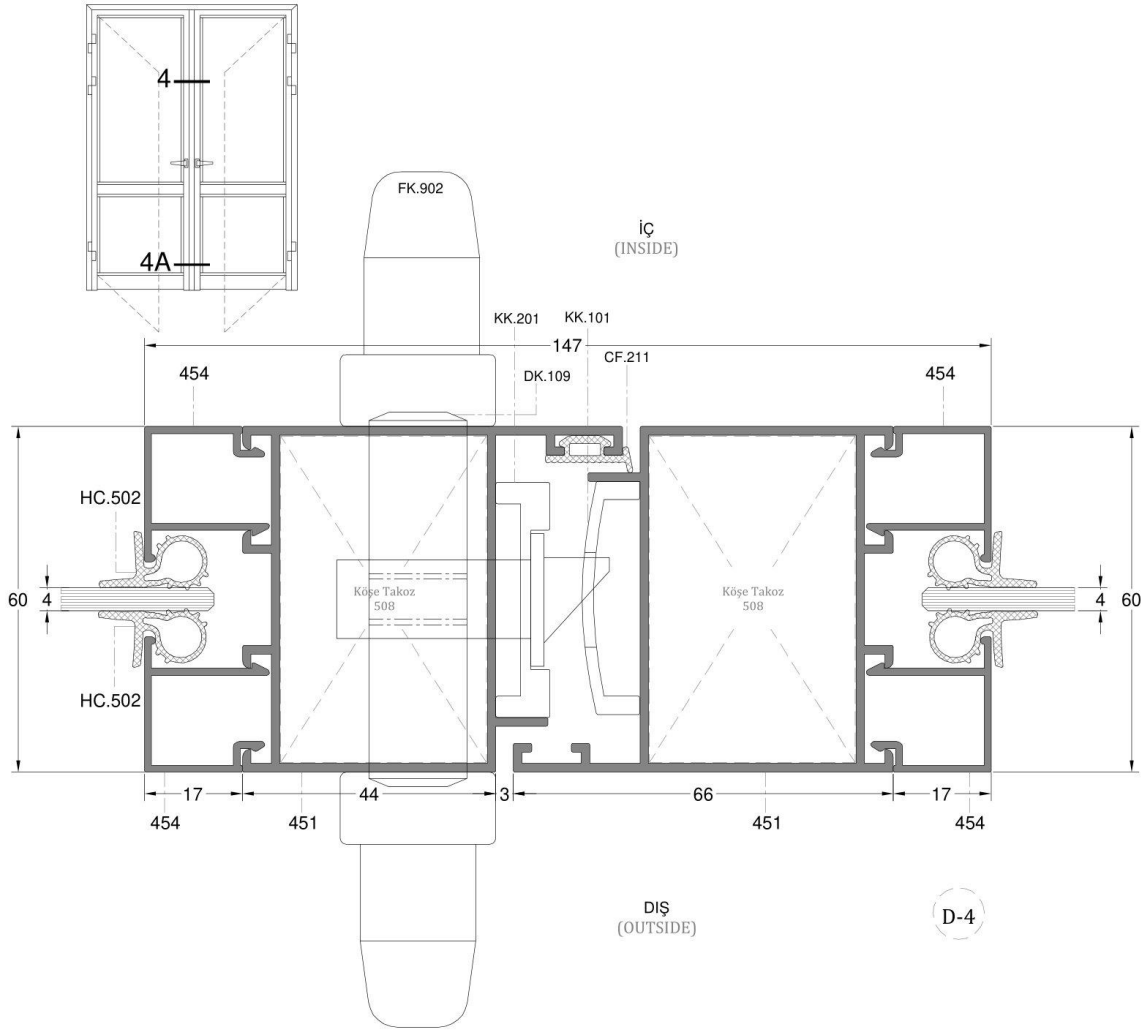

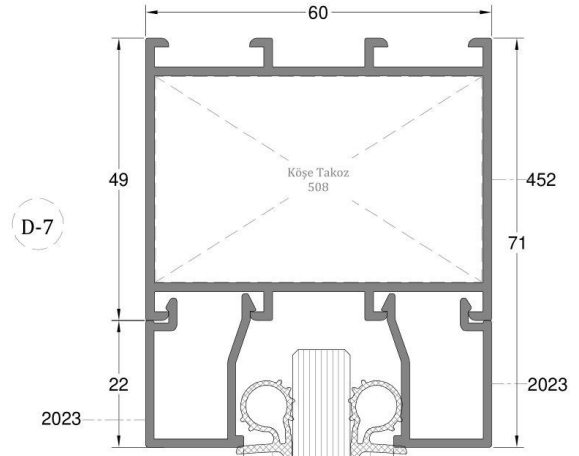
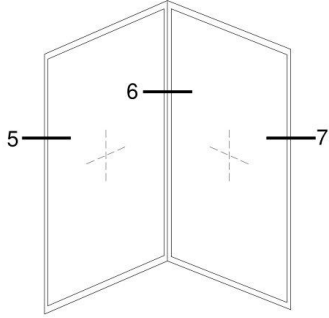

İÇ
(INSIDE)

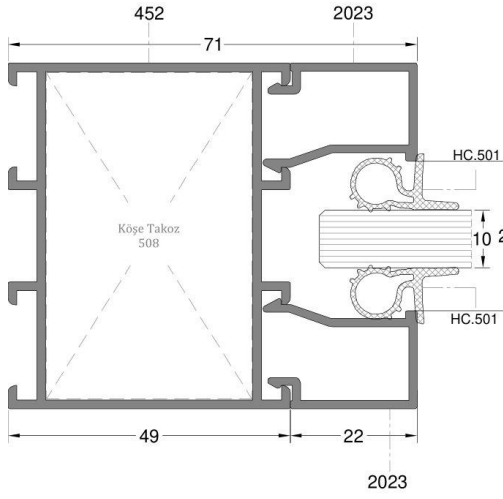

D-5

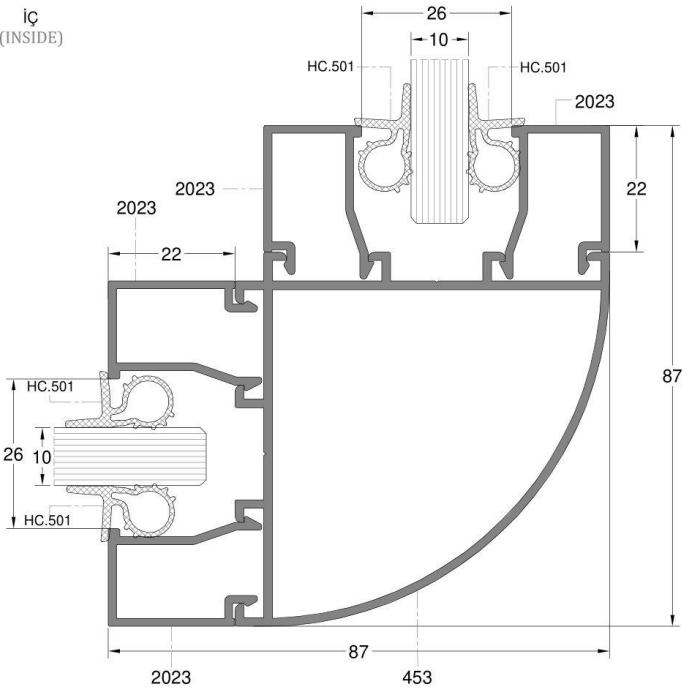

D-6

DIŞ
(OUTSIDE)