

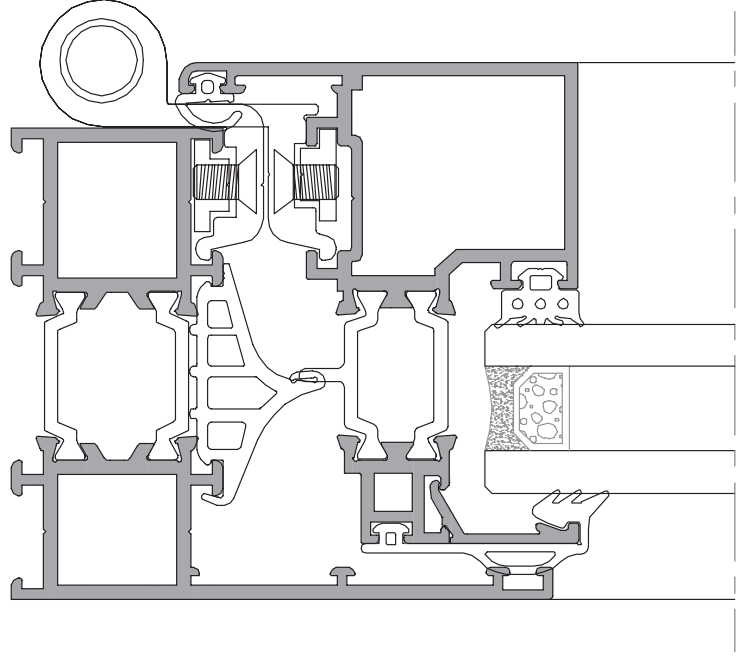

Kapı - Pencere Sistem
Door - Window System



HVT67



TEKNİK ÖZELLİKLER / TECHNICAL PROPERTIES

KASA DERİNLİĞİ / FRAME DEPTH	67 mm
KANAT DERİNLİĞİ / SASH DEPTH	68.5 mm
ET KALINLIĞI / WALL THICKNESS	2 mm
MİN/MAX CAM KALINLIĞI / MIN/MAX GLASS THICKNESS	24 mm - 26 mm
ISI BARIYER / THERMAL BREAK	24 mm
ISI YALITIM DEĞERİ / THERMAL INSULATION VALUE (UF)	2.20 - 2.37 W / (m² . K)

UYGULAMA SEÇENEKLERİ / APPLICATION OPTIONS

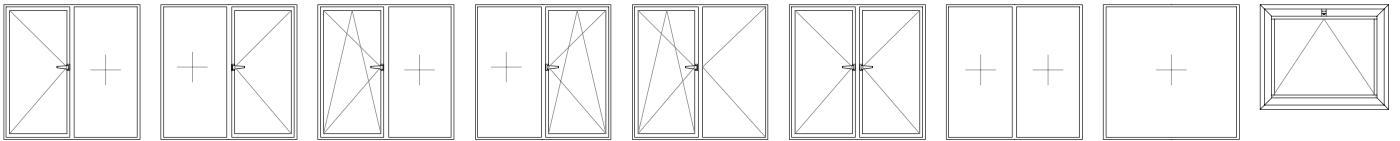

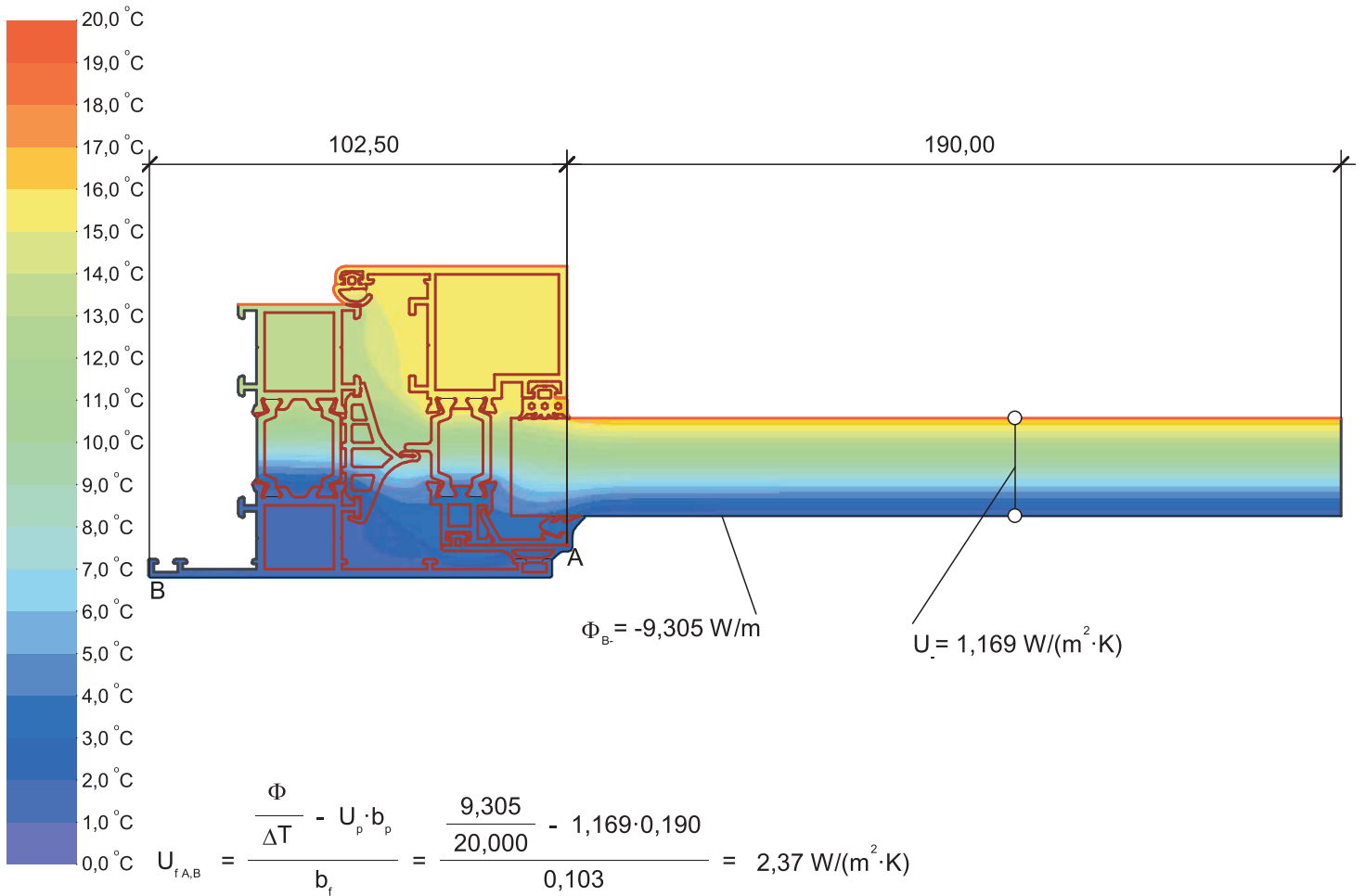





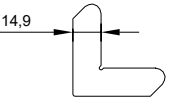
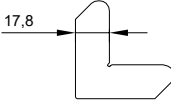
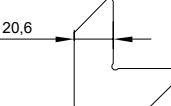
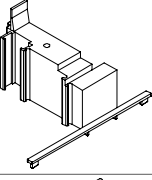

Material	λ [W/(m·K)]	ϵ	Boundary Condition	q [W/m ²]	θ [°C]	R [(m ² ·K)/W]	ϵ
Aluminium (Si Alloys)	160,000	0,900	Epsilon 0.9				0,900
EPDM (ethylene propylene diene monomer)	0,250	0,900	Exterior, frame	0,000		0,040	
Panel	0,035	0,900	Interior, normal, horizontal	20,000		0,130	
Polyamid 6.6 with 25% glass fibre	0,300	0,900	Symmetry/Model section	0,000			
Unventilated air cavity	anisotropic						

PROFİL KESİTİ PROFILE SECTION	PROFİL KODU PROFILE CODE	PROFİL ADI PROFILE NAME	Jx cm ⁴	Jy cm ⁴	AĞIRLIK (kg/m) WEIGHT
	67-11619-11628	KASA PROFİLİ FRAME PROFILE	32,10 cm ⁴	18,58 cm ⁴	1,640 kg/m
	67-11620-11629	KASA PROFİLİ FRAME PROFILE	29,49 cm ⁴	15,18 cm ⁴	1,530 kg/m
	67-11618-11619	ORTA KAYIT PROFİLİ MULLION PROFILE	35,18 cm ⁴	24,10 cm ⁴	1,785 kg/m
	67-11620-11621	ORTA KAYIT PROFİLİ MULLION PROFILE	32,68 cm ⁴	20,58 cm ⁴	1,670 kg/m
	67-11619-11632	ORTA KAYIT PROFİLİ MULLION PROFILE	38,04 cm ⁴	39,67 cm ⁴	1,930 kg/m
	67-11624-11622	KANAT PROFİLİ SASH PROFILE	22,57 cm ⁴	9,03 cm ⁴	1,473 kg/m
	67-11623-11622	KANAT PROFİLİ SASH PROFILE	24,84 cm ⁴	8,69 cm ⁴	1,446 kg/m
	67-11619-12262	TAKVİYELİ ORTA KAYIT PROFİLİ REINFORCED MULLION PROFILE	449,65 cm ⁴	79,92 cm ⁴	4,040 kg/m
	67-11631-11630	ADAPTÖR PROFİLİ ADAPTER PROFILE	-	-	1,690 kg/m
	11617	CAM YÜKSELTME ÇİTASI GLAZING ELEVATION BEAD	-	-	0,359 kg/m
	11616	CAM ÇİTASI (2,9 mm) GLAZING BEAD (2,9 mm)	-	-	0,117 kg/m
	8241	TİJ PROFİLİ STEM BAR PROFILE	-	-	0,099 kg/m
	3536	CAM ÇİTASI (31,5 mm) GLAZING BEAD (31,5 mm)	-	-	0,329 kg/m
	3636	CAM ÇİTASI (29,5 mm) GLAZING BEAD (29,5 mm)	-	-	0,321 kg/m
	3832	T BAĞLANTI PROFİLİ CONNECTION PROFILE	-	-	0,175 kg/m
	2045	KÖŞE TAKOZ PROFİLİ CORNER WEDGE PROFILE	-	-	1,436 kg/m
	11627	KÖŞE TAKOZ PROFİLİ CORNER WEDGE PROFILE	-	-	2,929 kg/m
	3088	KÖŞE TAKOZ PROFİLİ CORNER WEDGE PROFILE	-	-	3,498 kg/m
	1663	KÖŞE TAKOZ PROFİLİ CORNER WEDGE PROFILE	-	-	3,526 kg/m
	5022	KÖŞE TAKOZ PROFİLİ CORNER WEDGE PROFILE	-	-	2,245 kg/m
	11625	ORTA KAYIT BAĞLANTI PROFİLİ MULLION CONNECTION PROFILE	-	-	0,990 kg/m
	11626	ORTA KAYIT BAĞLANTI PROFİLİ MULLION CONNECTION PROFILE	-	-	1,502 kg/m

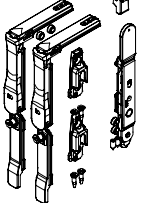

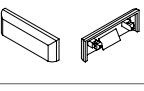
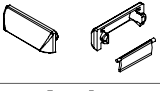
** Her profil için minimum sipariş 300 kg'dır.
** Minimum order quantity is 300 kg per profile.

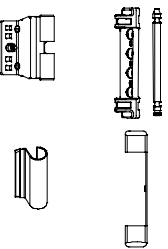
AKSESUAR ACCESSORY	STOK KODU REFERENCE CODE	AKSESUAR ADI DESCRIPTION	AKSESUAR KODU PRODUCT CODE	PAKET PACK
	03 010103	CEPHE İÇ CAM FİTİLİ SASH GASKET	HVT67-CF.03	175 mt / paket 10 kg
	03 010104	CEPHE İÇ CAM FİTİLİ SASH GASKET	HVT67-CF.04	150 mt / paket 10 kg
	03 010105	CEPHE İÇ CAM FİTİLİ FRAME GASKET	HVT67-CF.05	128 mt / paket 10 kg
	03 010500	KANAT FİTİLİ SASH GASKET	HVT67-KBF.15	230 mt / paket 10 kg
	03 010503	DIŞ CAM FİTİLİ OUTER GLAZING GASKET	HVT67-DCF.30	215 mt / paket 10 kg
	03 011230	İÇ CAM FİTİLİ INNER GLAZING GASKET	HVT67-İCF.30	330 mt / paket 10 kg
	03 011231	İÇ CAM FİTİLİ INNER GLAZING GASKET	HVT67-İCF.40	205 mt / paket 10 kg
	03 010732	İÇ CAM FİTİLİ INNER GLAZING GASKET	HVT67-İCF.50	175 mt / paket 10 kg
	03 011236	İÇ CAM FİTİLİ INNER GLAZING GASKET	HVT67-İCF.23	210 mt / paket 10 kg
	03 011237	İÇ CAM FİTİLİ INNER GLAZING GASKET	HVT67-İCF.45	255 mt / paket 10 kg
	03 011040	GİZLİ KANAT FİTİLİ HIDDEN SASH GASKET	HVT67-GKF.67	66 mt / paket 10 kg
	03 011034	ORTA BİNİ FİTİLİ MIDDLE GASKET	HVT67-OBF.67	38 mt / paket 10 kg
	03 070300	VULKANİZE KÖŞE BAĞLANTI VULCANIZED CORNER CONNECTION	HVT67-KVF.67	20 ad / 1 pk
	03 070301	VULKANİZE KÖŞE BAĞLANTI VULCANIZED CORNER CONNECTION	HVT67-KGVF.67	20 ad / 1 pk
	01 120201	AYARLI İSPANYOLET KARŞILIĞI (SETSKURLLU) ADJUSTABLE ESPAGNOLETTE RESPONSE (PINNED)	HVT67-TPK.201	100 ad / 1 pk
	01 120217	PVC KANALLI İSPANYOLET KARŞILIĞI PVC GROOVE ESPAGNOLETTE RESPONSE (SCREWED)	HVT67-PK.217	100 ad / 1 pk
	01 120100	İSPANYOLET PİMİ ESPAGNOLETTE PIN	HVT67-TP.100	100 ad / 1 pk
	06 140203	CAM TAKOZU(3X20X80 mm) GLAZING WEDGE (3X20X80 mm)	HVT67-CT.203	1000 ad / 1 pk
	06 140210	CAM TAKOZU(5X28X80 mm) GLAZING WEDGE (5X28X80 mm)	HVT67-CT.210	1000 ad / 1 pk
	06 140208	CAM TAKOZU(5X20X80 mm) GLAZING WEDGE (5X20X80 mm)	HVT67-CT.208	1000 ad / 1 pk

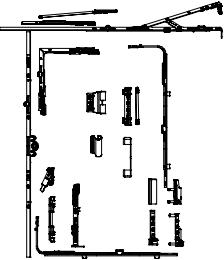
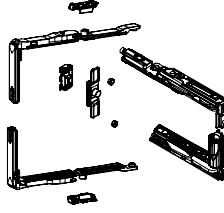
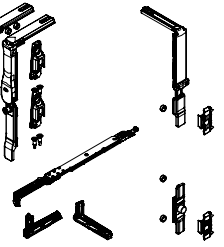
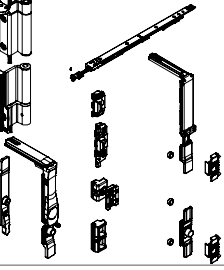
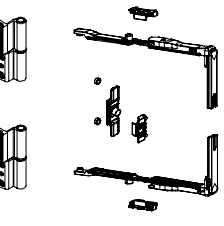
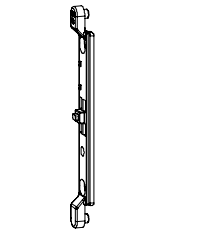
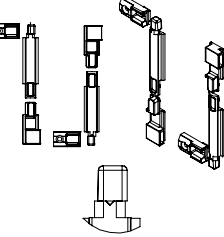
AKSESUAR ACCESSORY	STOK KODU REFERENCE CODE	AKSESUAR ADI DESCRIPTION	AKSESUAR KODU PRODUCT CODE	PAKET PACK
	01 120211	KANAT İÇİ KÖŞE GÖNYE CORNER BRACKET	HVT67-KG.149	500 ad / 1 pk
	01 120212	KANAT DIŞ KÖŞE GÖNYE CORNER BRACKET	HVT67-KG.178	500 ad / 1 pk
	01 120213	KANAT İÇİ KÖŞE GÖNYE CORNER BRACKET	HVT67-KG.206	500 ad / 1 pk
	01 120225	SİSTEM HVT67 ADAPTÖR KAPAĞI SYSTEM HVT67 ADAPTER COVER	HVT67-ADK.225	100 ad / 1 pk
	01 120214	CAM YANDAN DESTEK TAKOZ GLAZING WEDGE (SIDE)	HVT67-CT.214	20 ad / 1 pk
	01 120215	CAM ALTI DESTEK TAKOZ GLAZING WEDGE (BOTTOM)	HVT67-CT.215	20 ad / 1 pk
	01 120286	LEVYE KOL TWO WAY SHOOTBOLT LEVER KIT	HVT67-LK.286	1 ad / 1 pk
	01 120216	KASA KÖŞE GÖNYE (PVC) CORNER BRACKET	HVT67-CT.216	20 ad / 1 pk
	04 010115	SABİT PERDELİ YAĞMUR TAHLİYE KAPAK WATER DRAIN COVER (FIXED)	HVT67-TK.115	1000 ad / 1 pk
	04 010112	HAREKETLİ PERDELİ YAĞMUR TAHLİYE KAPAK WATER DRAIN COVER (MOVEABLE)	HVT67-TK.112	1000 ad / 1 pk
	01 120210	SİSTEM KANAT KALDIRMA TAKOZU SASH ADJUSTING BRACKET	HVT67-KST.210	50 ad / 1 pk
	01 120230	PVC KANALLI TEK AÇILIM MENTEŞE (13/18) PVC GROOVED CASEMENT HINGE (13/18)	HVT67-PM.230	100 ad / 1 pk

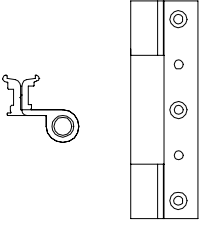
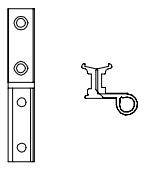
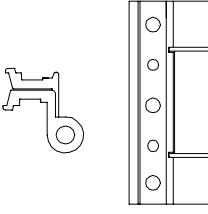
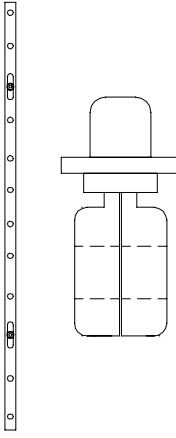
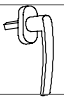
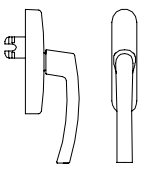
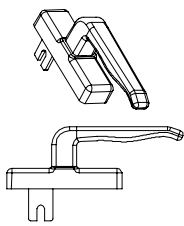
AKSESUAR ACCESSORY	STOK KODU REFERENCE CODE	AKSESUAR ADI DESCRIPTION	AKSESUAR KODU PRODUCT CODE	PAKET PACK
	01 120250	PVC KANALLI ÇİFT AÇILIM MENTEŞE (13/18) PVC GROOVED TILT & TURN HINGE (13/18)	HVT67-PM.250	100 ad / 1 pk
	01 120350	GİZLİ MENTEŞELİ TEK AÇILIM SETİ (SAĞ-SOL) CASEMENT SET WITH CONCEALED HINGE	HVT67-GM.350	TAŞIMA KAPASİTESİ 100 KG LOADING CAPACITY 100 KG
	01 120351	GİZLİ MENTEŞELİ ÇİFT AÇILIM SETİ (SAĞ-SOL) CASEMENT SET WITH CONCEALED HINGE TILT-TURN SET	HVT67-GM.351	TAŞIMA KAPASİTESİ 100 KG LOADING CAPACITY 100 KG
	01 120352	ÇİFT AÇILIM SETİ TILT-TURN SET	HVT67-CS.352	TAŞIMA KAPASİTESİ MENTEŞE KİTİ DEĞİŞTİRİLEREK 90 İLE 160 KG ARALIĞINDA TERCİH EDİLEBİLİR. Depending on the hinge selection loading capacity can be between 90-160 kg.
	01 120353	TEK AÇILIM SETİ CASEMENT SET	HVT67-TS.353	TAŞIMA KAPASİTESİ MENTEŞE KİTİ DEĞİŞTİRİLEREK 65 İLE 160 KG ARALIĞINDA TERCİH EDİLEBİLİR. Depending on the hinge selection loading capacity can be between 65-160 kg.
	01 120610	TEK MAÇALI KOL TİJ BAĞLANTI SINGLE HANDLE STEM BAR CONNECTION	HVT67-TTB.610	
	01 120600	ÇİFT MAÇALI KOL TİJ BAĞLANTI DOUBLE HANDLE STEM BAR CONNECTION	HVT67-ÇTB.600	

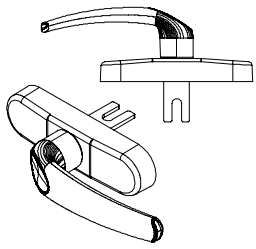
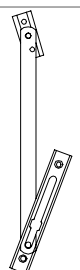
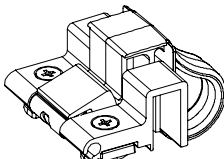
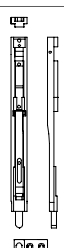
AKSESUAR ACCESSORY	STOK KODU REFERENCE CODE	AKSESUAR ADI DESCRIPTION	AKSESUAR KODU PRODUCT CODE	PAKET PACK
	01 011111	SİSTEM KAPI MENTEŞE (ELOKSALLI) SYSTEM DOOR HINGE (ANODIZED)	HVT67-KM.111	10 ad / 1 pk
	01 011112	SİSTEM KAPI MENTEŞE (BEYAZ) SYSTEM DOOR HINGE (WHITE)	HVT67-KM.112	10 ad / 1 pk
	01 011113	SİSTEM KAPI MENTEŞE (RENKLİ) SYSTEM DOOR HINGE (COLORED)	HVT67-KM.113	10 ad / 1 pk
	01 010901	SİSTEM PENCERE MENTEŞE (ELOKSALLI) SYSTEM WINDOW HINGE (ANODIZED)	HVT67-PM.901	10 ad / 1 pk
	01 010902	SİSTEM PENCERE MENTEŞE (BEYAZ) SYSTEM WINDOW HINGE (WHITE)	HVT67-PM.902	10 ad / 1 pk
	01 010903	SİSTEM PENCERE MENTEŞE (RENKLİ) SYSTEM WINDOW HINGE (COLORED)	HVT67-PM.903	10 ad / 1 pk
	01 011101	SİSTEM PENCERE VE KAPI MENTEŞE (ELOKSALLI) SYSTEM WINDOW AND DOOR HINGE (ANODIZED)	HVT67-PKM.101	10 ad / 1 pk
	01 011102	SİSTEM PENCERE VE KAPI MENTEŞE (BEYAZ) SYSTEM WINDOW AND DOOR HINGE (WHITE)	HVT67-PKM.102	10 ad / 1 pk
	01 011103	SİSTEM PENCERE VE KAPI MENTEŞE (RENKLİ) SYSTEM WINDOW AND DOOR HINGE (COLORED)	HVT67-PKM.103	10 ad / 1 pk
	06 010452	İSPANYOLET-80 cm ESPAGNOLETTE-80 cm	HVT67-İSP.452	1 ad / 1 pk
	06 010453	İSPANYOLET-100 cm ESPAGNOLETTE-100 cm	HVT67-İSP.453	1 ad / 1 pk
	06 010454	İSPANYOLET-120 cm ESPAGNOLETTE-120 cm	HVT67-İSP.454	1 ad / 1 pk
	06 010455	İSPANYOLET-140 cm ESPAGNOLETTE-140 cm	HVT67-İSP.455	1 ad / 1 pk
	06 010456	İSPANYOLET-160 cm ESPAGNOLETTE-160 cm	HVT67-İSP.456	1 ad / 1 pk
	06 010457	İSPANYOLET-180 cm ESPAGNOLETTE-180 cm	HVT67-İSP.457	1 ad / 1 pk
	01 200291	ROTO SECUSTİK PENCERE KOLU ROTO WINDOW HANDLE	HVT67-RK.291	20 ad / 1 pk
	01 020601	EKSENEL KOL ROTO (ELOKSALLI) ROTO AXIAL HANDLE (ANODIZED)	HVT67-RK.601	10 ad / 1 pk
	01 020604	EKSENEL KOL ROTO (ELOKSALLI KİLİTLİ) ROTO AXIAL HANDLE (ANODIZED LOCKED)	HVT67-RK.604	10 ad / 1 pk
	01 020810	FORZA YANKI EKSENEL PENCERE KOLU (NATUREL) FORZA YANKI AXIAL WINDOW HANDLE (NATURAL)	HVT67-EK.810	50 ad / 1 pk
	01 020811	FORZA YANKI EKSENEL PENCERE KOLU (BEYAZ) FORZA YANKI AXIAL WINDOW HANDLE (WHITE)	HVT67-EK.811	50 ad / 1 pk
	01 020812	FORZA YANKI EKSENEL PENCERE KOLU (RENKLİ) FORZA YANKI AXIAL WINDOW HANDLE (COLORED)	HVT67-EK.812	50 ad / 1 pk

AKSESUAR ACCESSORY	STOK KODU REFERENCE CODE	AKSESUAR ADI DESCRIPTION	AKSESUAR KODU PRODUCT CODE	PAKET PACK
	01 020702	FORZA EFOR EKSENEL PENCERE KOLU (BEYAZ) FORZA EFOR AXIAL WINDOW HANDLE (WHITE)	HVT67-FPK.702	20 ad / 1 pk
	01 020703	FORZA EFOR EKSENEL PENCERE KOLU (RENKLİ) FORZA EFOR AXIAL WINDOW HANDLE (COLORED)	HVT67-FPK.703	20 ad / 1 pk
	01 020803	FORZA EFOR EKSENEL PENCERE KOLU (NATUREL) FORZA EFOR AXIAL WINDOW HANDLE (NATURAL)	HVT67-FPK.803	20 ad / 1 pk
	01 080301	SİSTEM 13 CM VASİSTAS MAKAS (NATUREL) SYSTEM 13 CM TRANSOM TRUSS (ANODIZED)	HVT67-VM.301	50 ad / 1 pk
	01 080302	SİSTEM 13 CM VASİSTAS MAKAS (BEYAZ) SYSTEM 13 CM TRANSOM TRUSS (WHITE)	HVT67-VM.302	50 ad / 1 pk
	01 080303	SİSTEM 13 CM VASİSTAS MAKAS (RENKLİ) SYSTEM 13 CM TRANSOM TRUSS (COLORED)	HVT67-VM.303	50 ad / 1 pk
	01 080401	SİSTEM 22 CM VASİSTAS MAKAS (NATUREL) SYSTEM 22 CM TRANSOM TRUSS (ANODIZED)	HVT67-VM.401	50 ad / 1 pk
	01 080402	SİSTEM 22 CM VASİSTAS MAKAS (BEYAZ) SYSTEM 22 CM TRANSOM TRUSS (WHITE)	HVT67-VM.402	50 ad / 1 pk
	01 080403	SİSTEM 22 CM VASİSTAS MAKAS (RENKLİ) SYSTEM 22 CM TRANSOM TRUSS (COLORED)	HVT67-VM.403	50 ad / 1 pk
	01 081702	SİSTEM AYARLI VASİSTAS ÇARPMA (NATUREL) SYSTEM TRANSOM CATCH (NATURAL)	HVT67-VÇ.702	100 ad / 1 pk
	01 081703	SİSTEM AYARLI VASİSTAS ÇARPMA (BEYAZ) SYSTEM TRANSOM CATCH (WHITE)	HVT67-VÇ.703	100 ad / 1 pk
	01 081704	SİSTEM AYARLI VASİSTAS ÇARPMA (RENKLİ) SYSTEM TRANSOM CATCH (COLORED)	HVT67-VÇ.704	100 ad / 1 pk
	01 070201	SİSTEM UZUN ZAMAK SÜRGÜ (NATUREL) SYSTEM ZAMAK LATCH (NATURAL)	HVT67-FS.201	10 ad / 1 pk
	01 070202	SİSTEM UZUN ZAMAK SÜRGÜ (BEYAZ) SYSTEM ZAMAK LATCH (WHITE)	HVT67-FS.202	10 ad / 1 pk
	01 070203	SİSTEM UZUN ZAMAK SÜRGÜ (RENKLİ) SYSTEM ZAMAK LATCH (COLORED)	HVT67-FS.203	10 ad / 1 pk
	11 010206	CAM YANDAN DESTEK TAKOZ VİDASI (3.9x38 mm YSB M.U.V) Ø3.9x38 mm SELF DRILLING CURVED TOP SCREW	HVT67-SC.206	1000 ad / 1 pk
	11 010200	CAM YANDAN DESTEK TAKOZ VİDASI (3.9x13 mm YSB M.U.V) Ø3.9x13 mm SELF DRILLING CURVED TOP SCREW	HVT67-SC.200	1000 ad / 1 pk

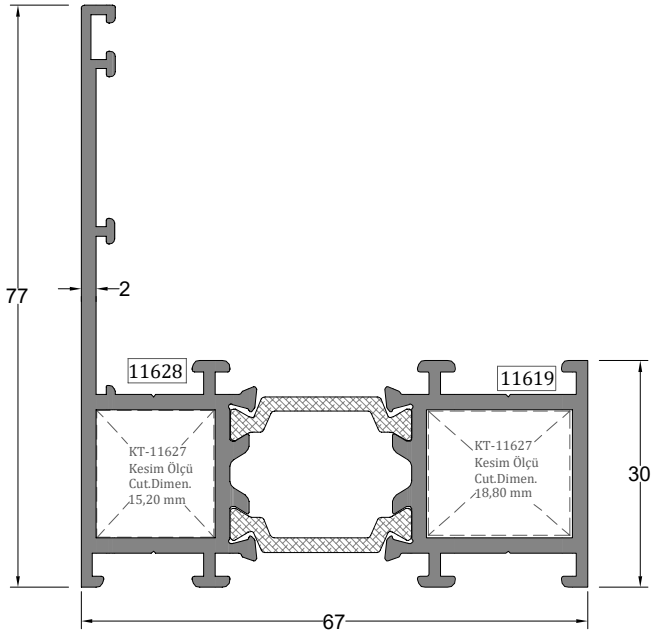

Kasa Profili FRAME PROFILE	Profil Kodu Profile Code	(kg/mt) Weight	Jx cm ⁴	Jy cm ⁴
	67-11619-11628	1,640	32,10	18,58

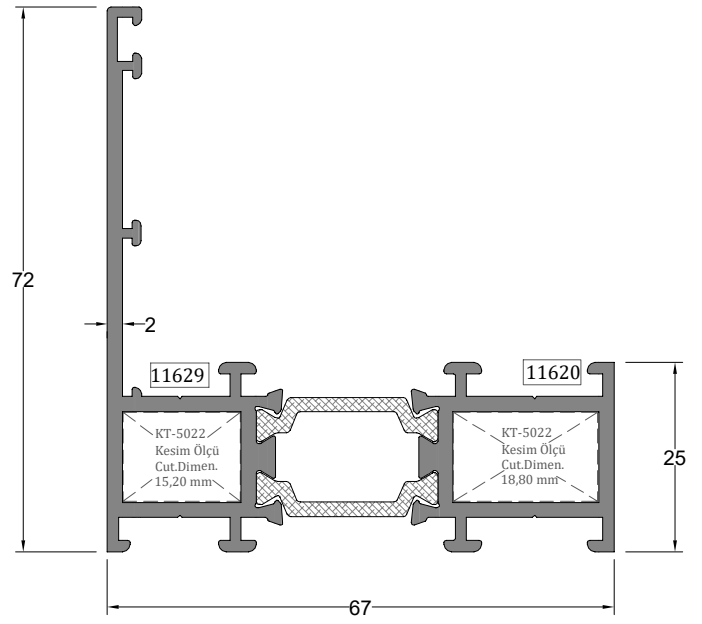

Kasa Profili FRAME PROFILE	Profil Kodu Profile Code	(kg/mt) Weight	Jx cm ⁴	Jy cm ⁴
	67-11620-11629	1,530	29,49	15,18

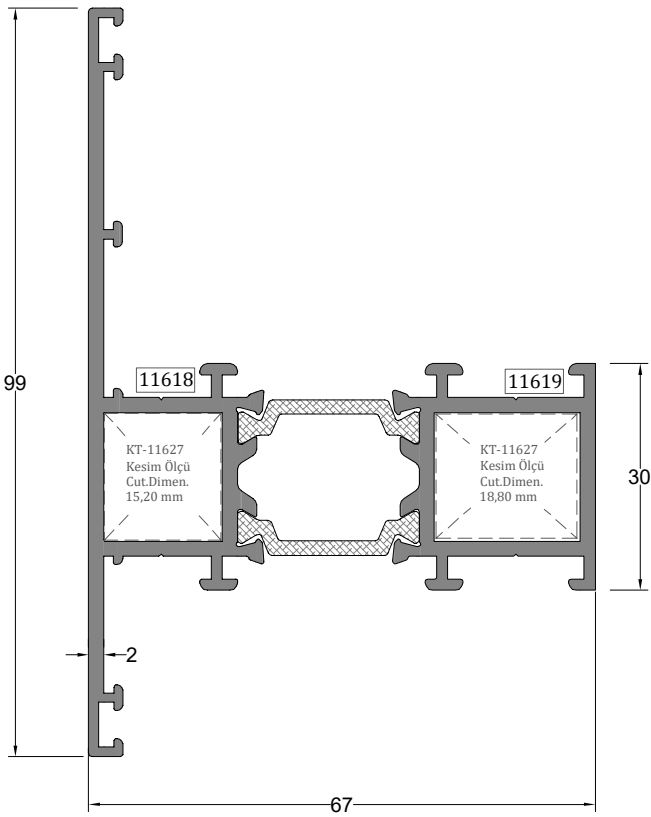

Orta Kayıt Profili MULLION PROFILE	Profil Kodu Profile Code	(kg/mt) Weight	Jx cm ⁴	Jy cm ⁴
	67-11618-11619	1,785	35,18	24,10

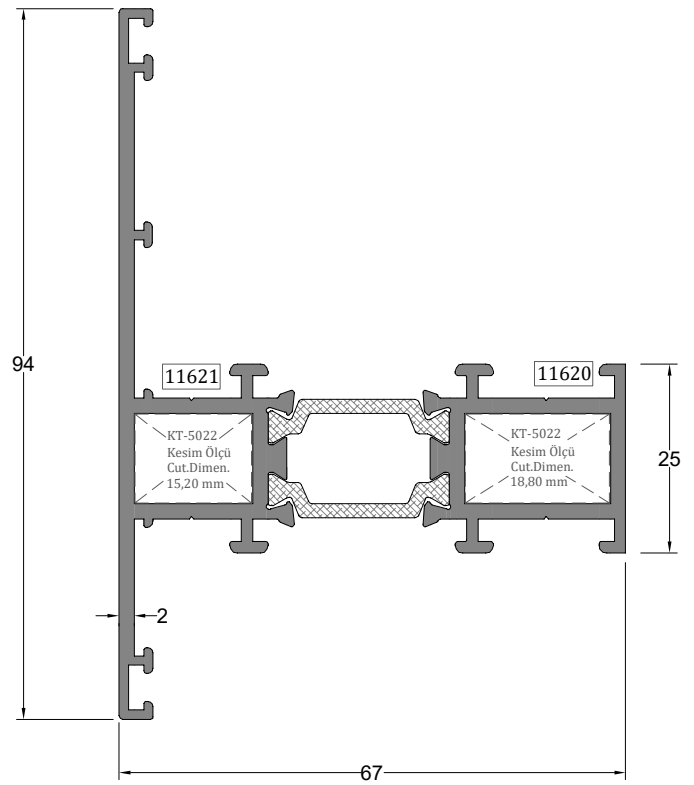

Orta Kayıt Profili MULLION PROFILE	Profil Kodu Profile Code	(kg/mt) Weight	Jx cm ⁴	Jy cm ⁴
	67-11620-11621	1,670	32,68	20,58

** Her profil için minimum sipariş 300 kg'dır.
** Minimum order quantity is 300 kg per profile.

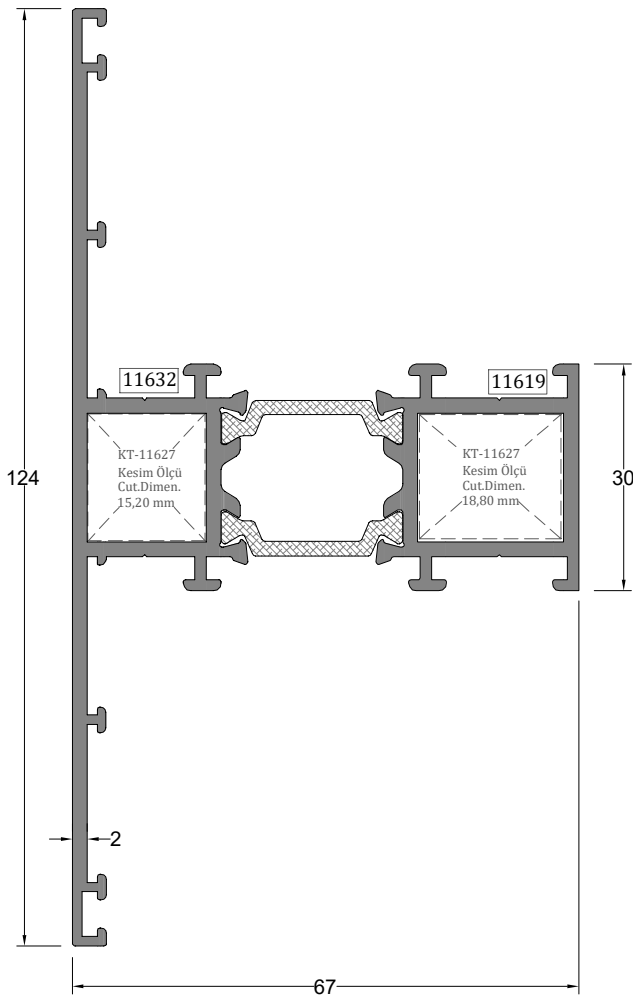

Orta Kayıt Profili	Profil Kodu	(kg/mt)	Jx cm ⁴	Jy cm ⁴
MULLION PROFILE	Profile Code	Weight		
	67-11619-11632	1,930	38,04	39,67

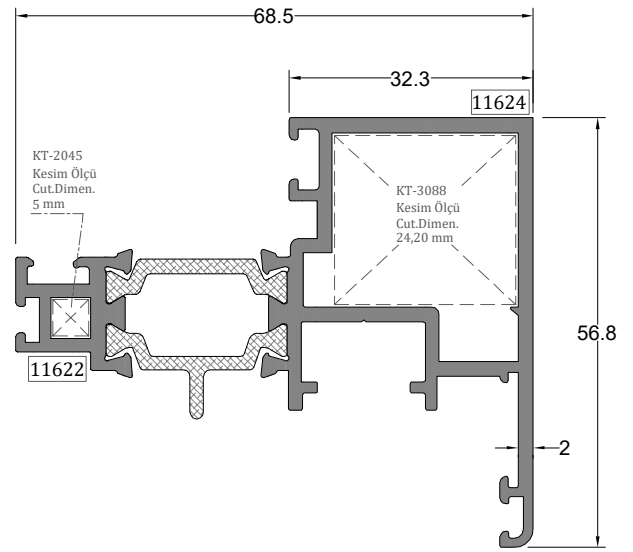

Kanat Profili	Profil Kodu	(kg/mt)	Jx cm ⁴	Jy cm ⁴
SASH PROFILE	Profile Code	Weight		
	67-11624-11622	1,473	22,57	9,03

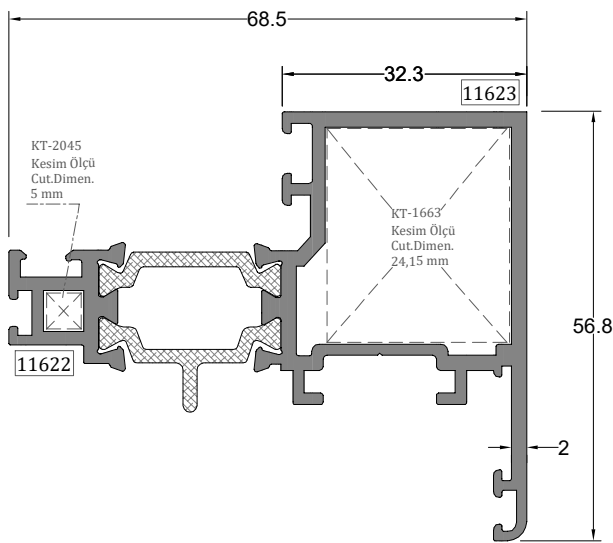

Kanat Profili	Profil Kodu	(kg/mt)	Jx cm ⁴	Jy cm ⁴
SASH PROFILE	Profile Code	Weight		
	67-11623-11622	1,446	24,84	8,69

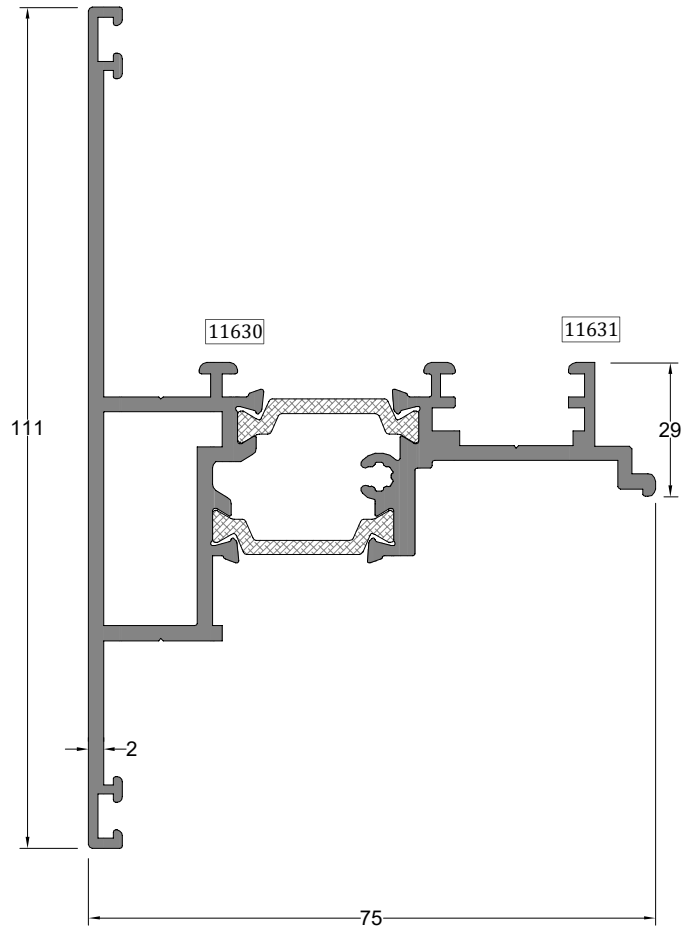

Adaptör Profili	Profil Kodu	(kg/mt)
ADAPTER PROFILE	Profile Code	Weight
	67-11631-11630	1,690

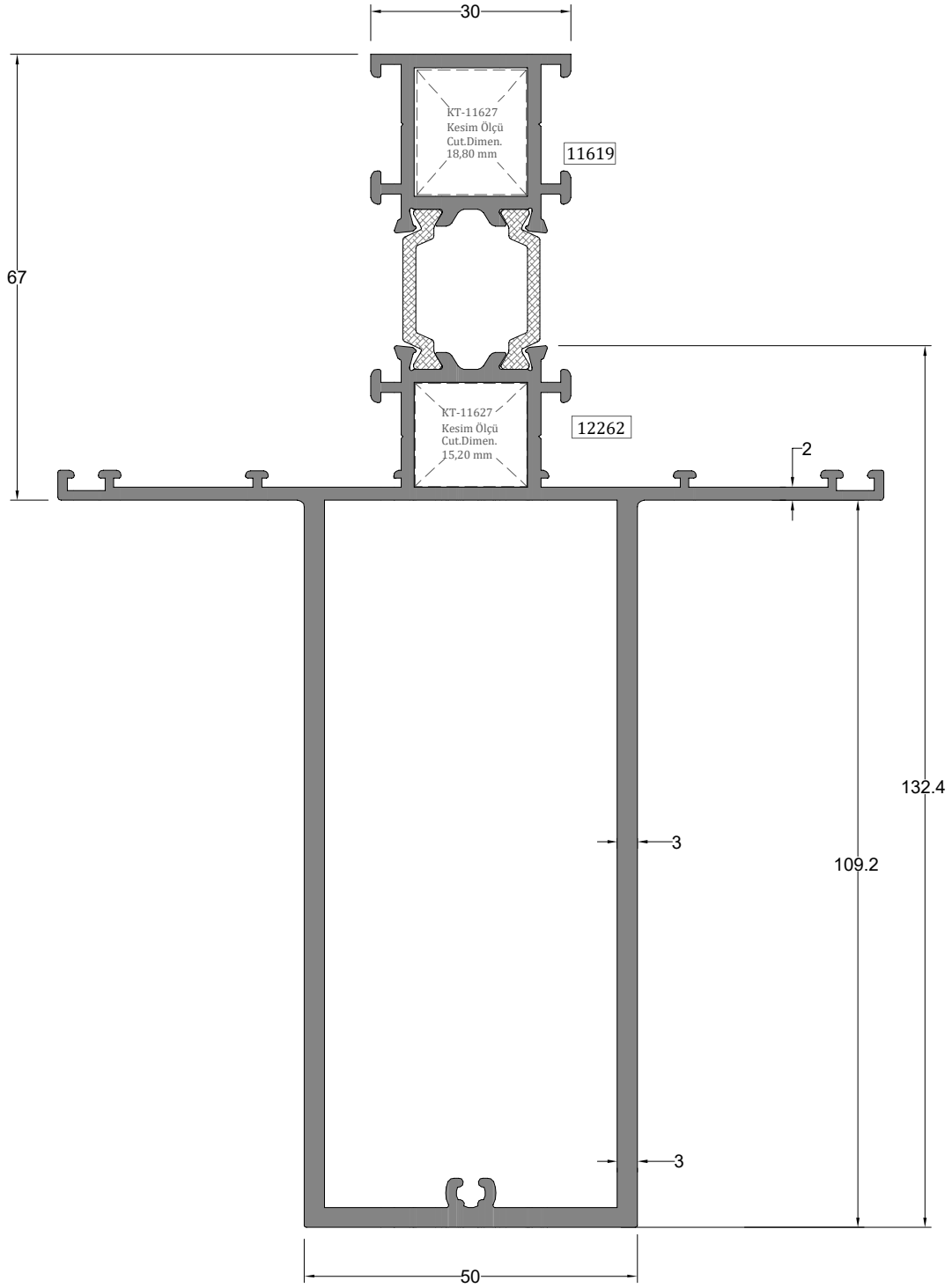

Takviyeli Orta Kayıt Profili	Profil Kodu	(kg/mt)	Jx cm ⁴	Jy cm ⁴
REINFORCED MULLION PROFILE	Profile Code	Weight		
	67-11619-12262	4,040	449,65	79,92

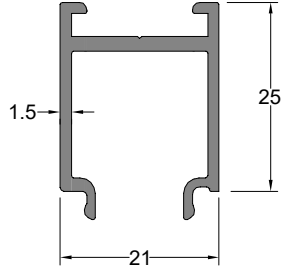

Cam Yükseltme Çıtası GLAZING ELEVATION BEAD	Profil Kodu Profile Code	(kg/mt) Weight
	11617	0,359

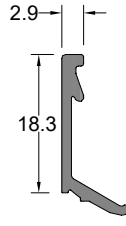

Cam Çıtası GLAZING BEAD	Profil Kodu Profile Code	(kg/mt) Weight
	11616	0,117

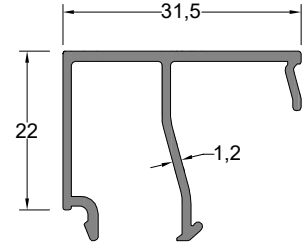

Cam Çıtası GLAZING BEAD	Profil Kodu Profile Code	(kg/mt) Weight
	3536	0,329

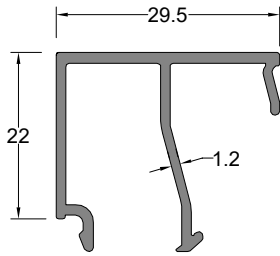

Cam Çıtası GLAZING BEAD	Profil Kodu Profile Code	(kg/mt) Weight
	3636	0,321

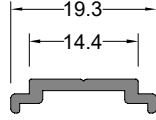

Tij Profili STEM BAR PROFILE	Profil Kodu Profile Code	(kg/mt) Weight
	8241	0,099

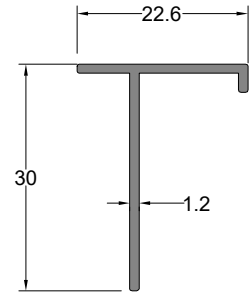

T Bağlantı Profili CONNECTION PROFILE	Profil Kodu Profile Code	(kg/mt) Weight
	3832	0,175

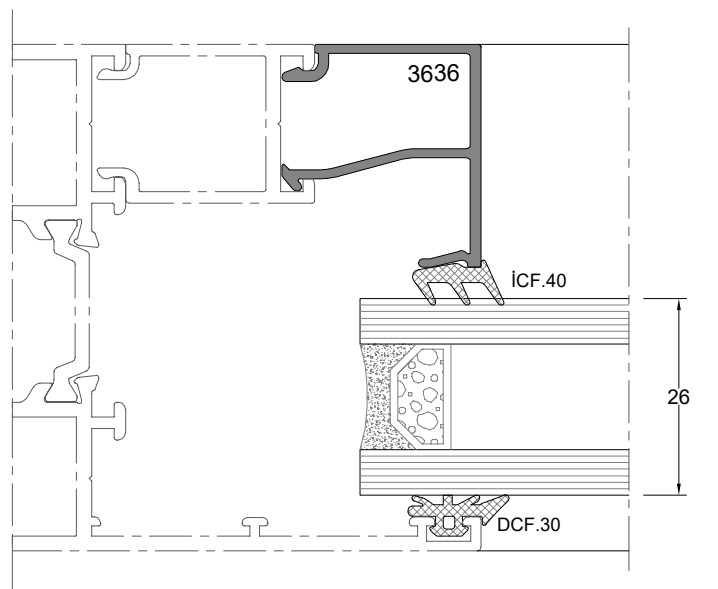
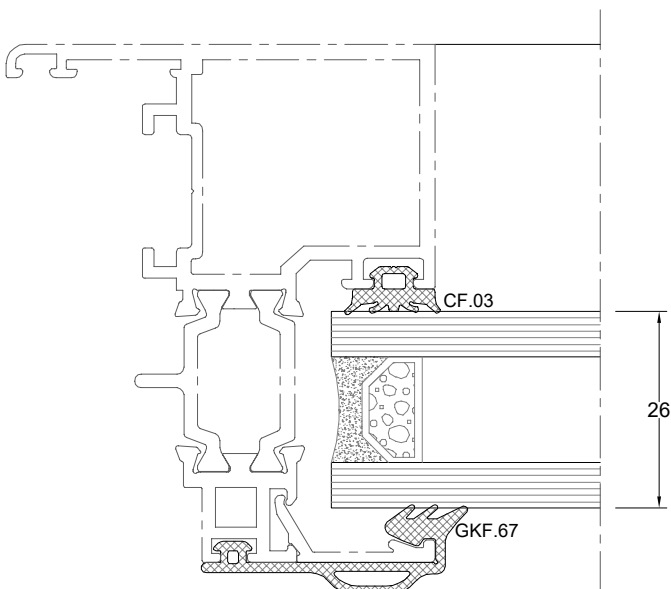
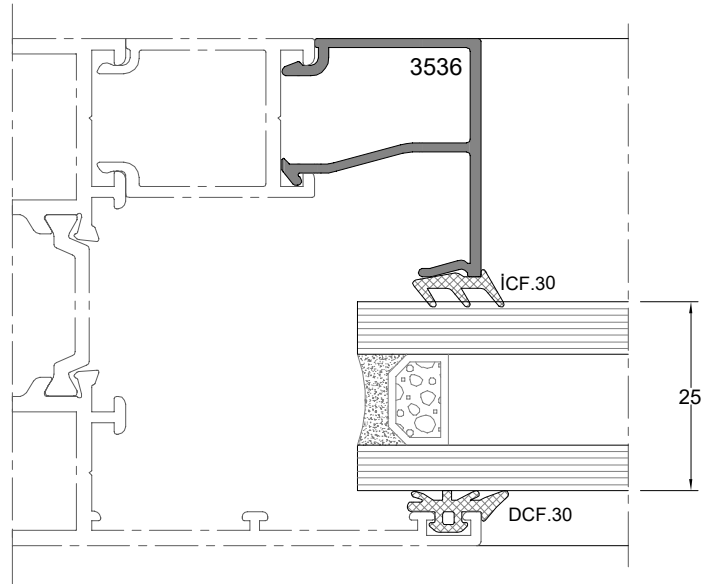
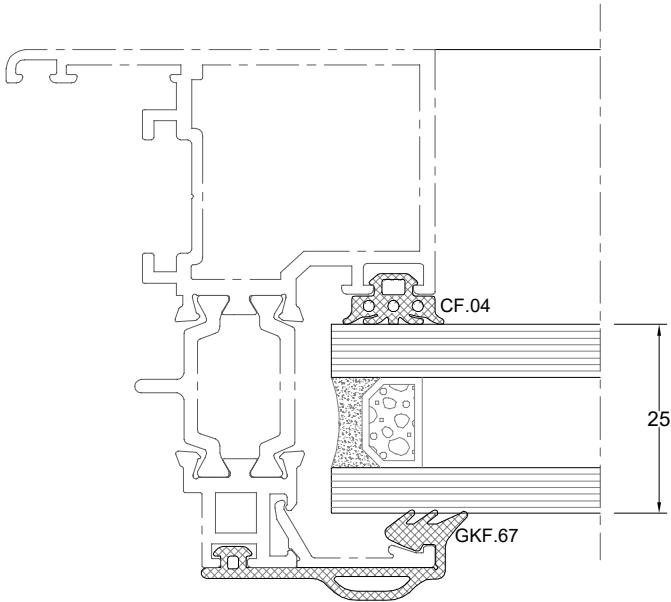
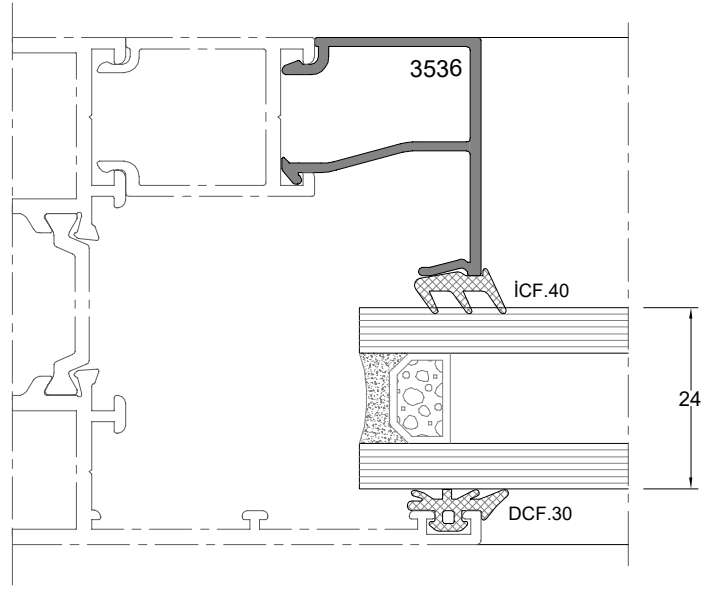
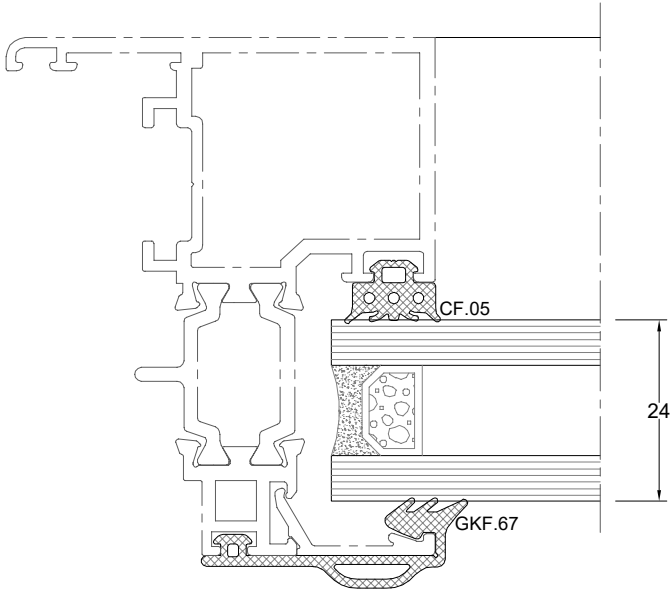

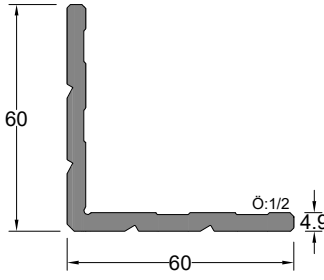

Köşe Takoz Profili	Profil Kodu	(kg/mt)
CORNER WEDGE PROFILE	Profile Code	Weight
	2045	1,436

Köşe Takozu Profil Kodu	Kullanıldığı Profil	Kesim Boyu (mm)
Corner Wedge Profile Code	Compatible Profile	Cutting Length (mm)
2045	11622	5,00 mm

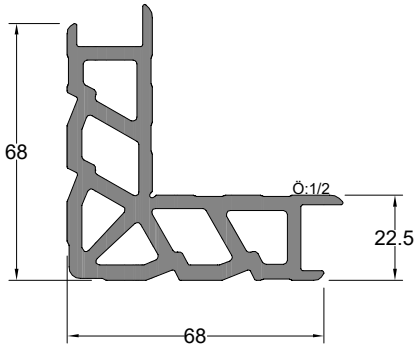

Köşe Takoz Profili	Profil Kodu	(kg/mt)
CORNER WEDGE PROFILE	Profile Code	Weight
	3088	3,498

Köşe Takozu Profil Kodu	Kullanıldığı Profil	Kesim Boyu (mm)
Corner Wedge Profile Code	Compatible Profile	Cutting Length (mm)
3088	11624	24,20 mm

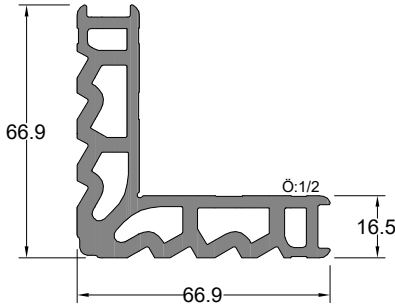

Köşe Takoz Profili	Profil Kodu	(kg/mt)
CORNER WEDGE PROFILE	Profile Code	Weight
	11627	2,929

Köşe Takozu Profil Kodu	Kullanıldığı Profil	Kesim Boyu (mm)
Corner Wedge Profile Code	Compatible Profile	Cutting Length (mm)
11627	11619	18,80 mm
	11618	15,20 mm
	11628	15,20 mm
	11632	15,20 mm

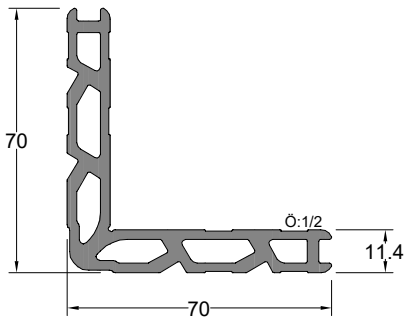

Köşe Takoz Profili	Profil Kodu	(kg/mt)
CORNER WEDGE PROFILE	Profile Code	Weight
	5022	2,245

Köşe Takozu Profil Kodu	Kullanıldığı Profil	Kesim Boyu (mm)
Corner Wedge Profile Code	Compatible Profile	Cutting Length (mm)
5022	11620	18,80 mm
	11621	15,20 mm
	11629	15,20 mm

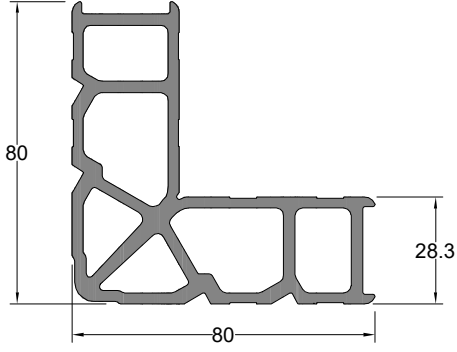

Köşe Takozu Profil Kodu Corner Wedge Profile Code	Kullanıldığı Profil Compatible Profile	Kesim Boyu (mm) Cutting Length (mm)
1663	11623	24,15 mm

Köşe Takoz Profili CORNER WEDGE PROFILE	Profil Kodu Profile Code	(kg/mt) Weight
	1663	3,526

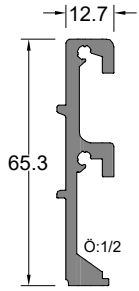

Orta Kayıt Bağlantı Profil Kodu Mullion Connection Profile Code	Stok Kodu Reference Code	Kullanıldığı Profil Compatible Profile	Kesim Boyu (mm) Cutting Length (mm)
11625	OKB-11625-11,5	11620	11,50 mm
	OKB-11625-16,5	11618	16,50 mm
	OKB-11625-16,5	11632	16,50 mm

Orta Kayıt Bağlantı Profili MULLION CONNECTION PROFILE	Profil Kodu Profile Code	(kg/mt) Weight
	11625	0,990

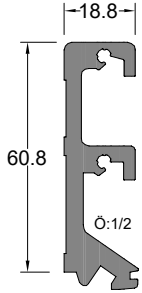

Orta Kayıt Bağlantı Profil Kodu Mullion Connection Profile Code	Stok Kodu Reference Code	Kullanıldığı Profil Compatible Profile	Kesim Boyu (mm) Cutting Length (mm)
11626	OKB-11626-11,5	11621	11,50 mm
	OKB-11626-16,5	11619	16,50 mm

Orta Kayıt Bağlantı Profili MULLION CONNECTION PROFILE	Profil Kodu Profile Code	(kg/mt) Weight
	11626	1,502

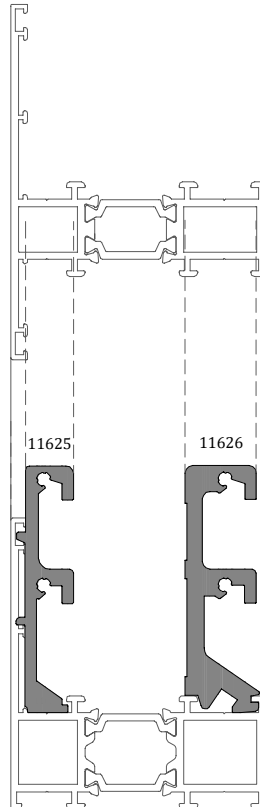

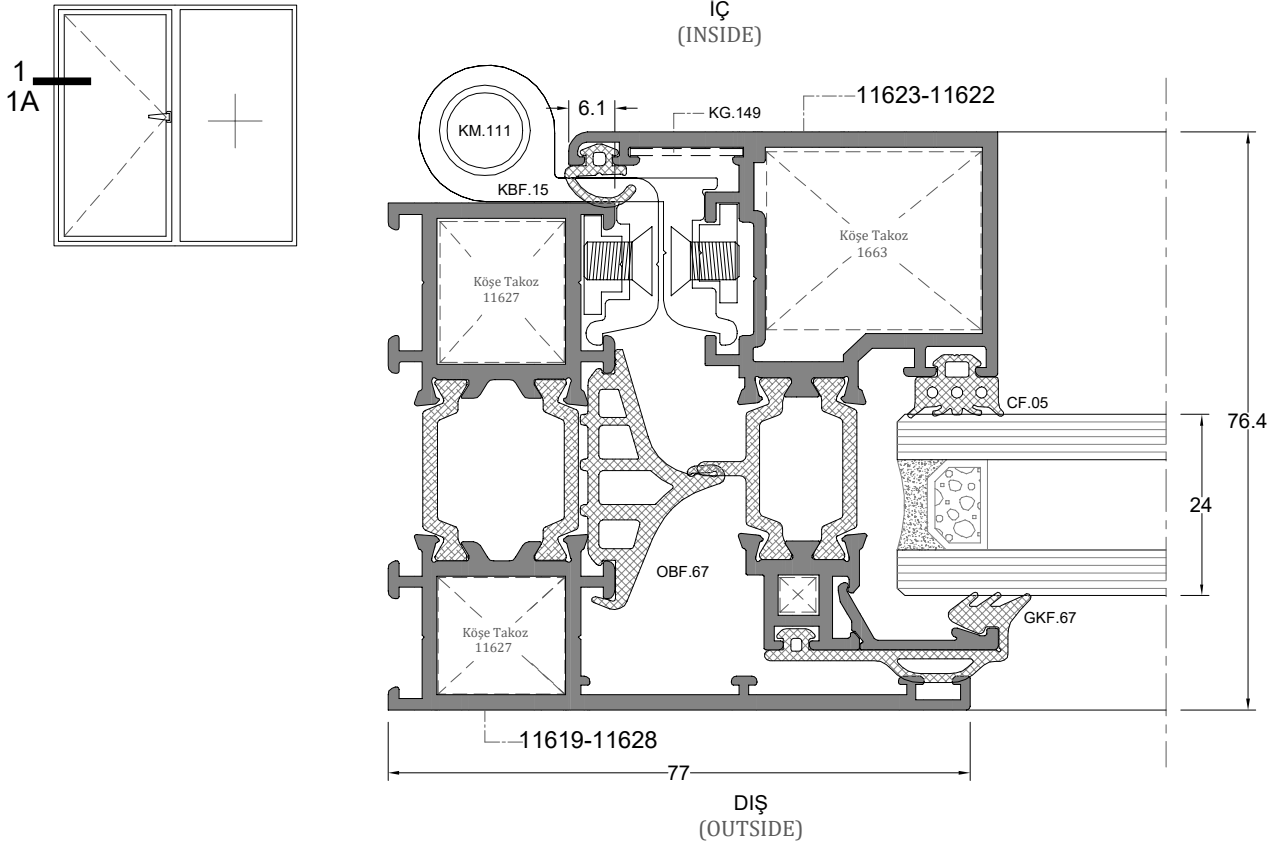

D-1

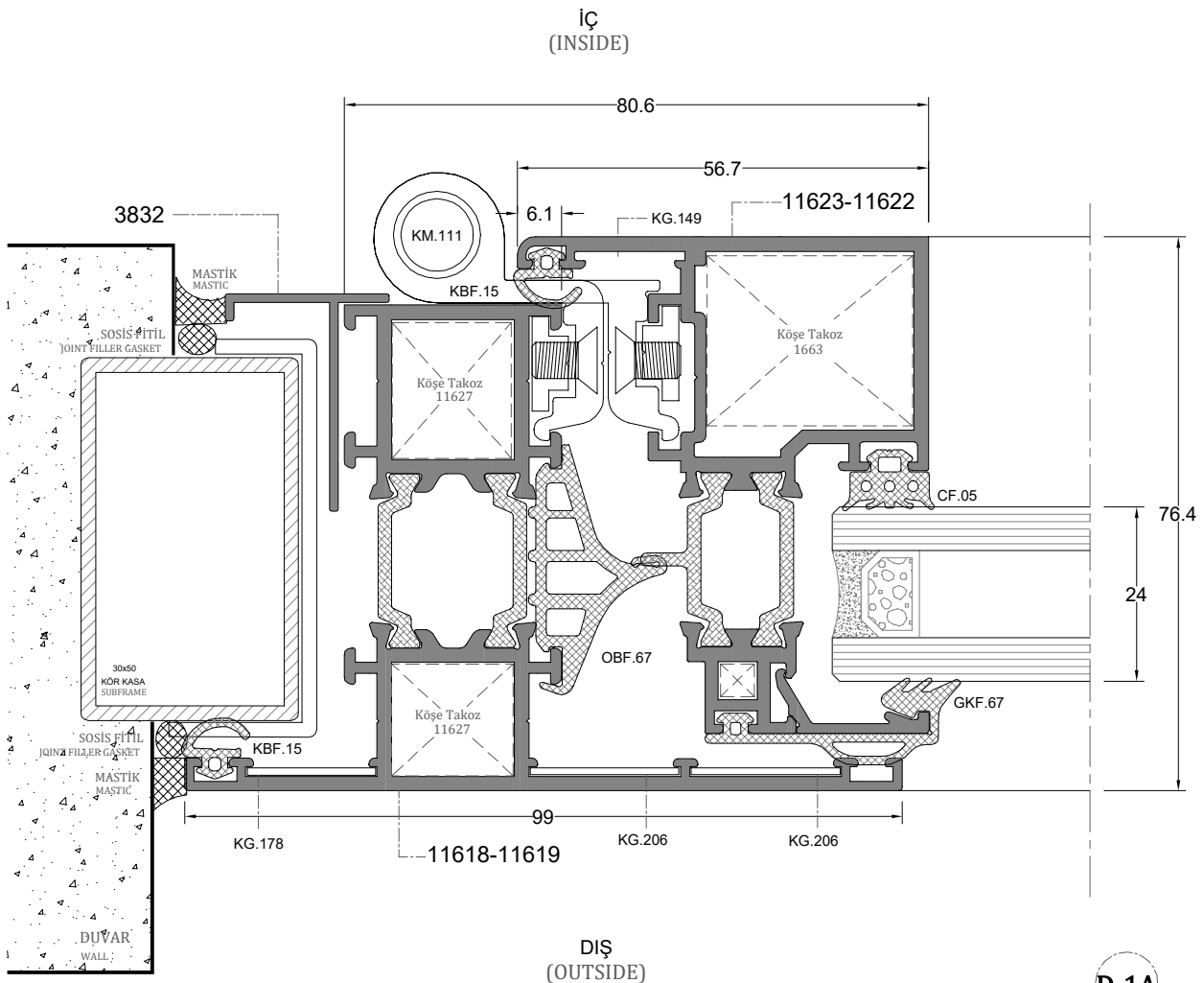

D-1A

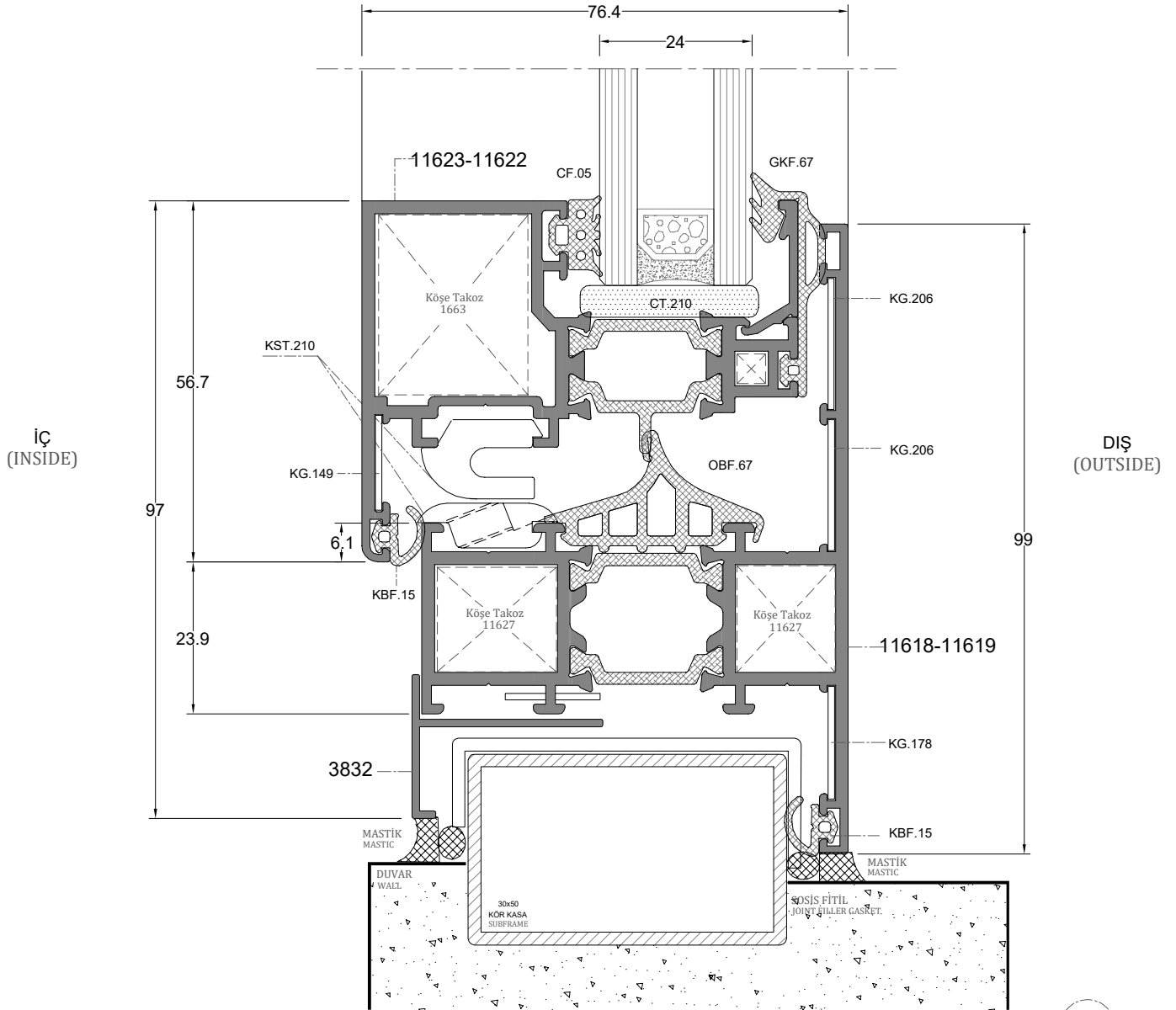
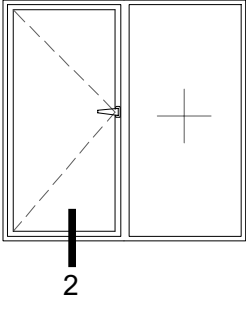

D-2

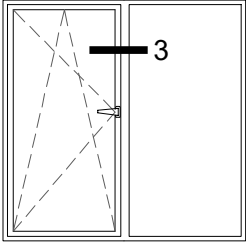

İÇ
(INSIDE)

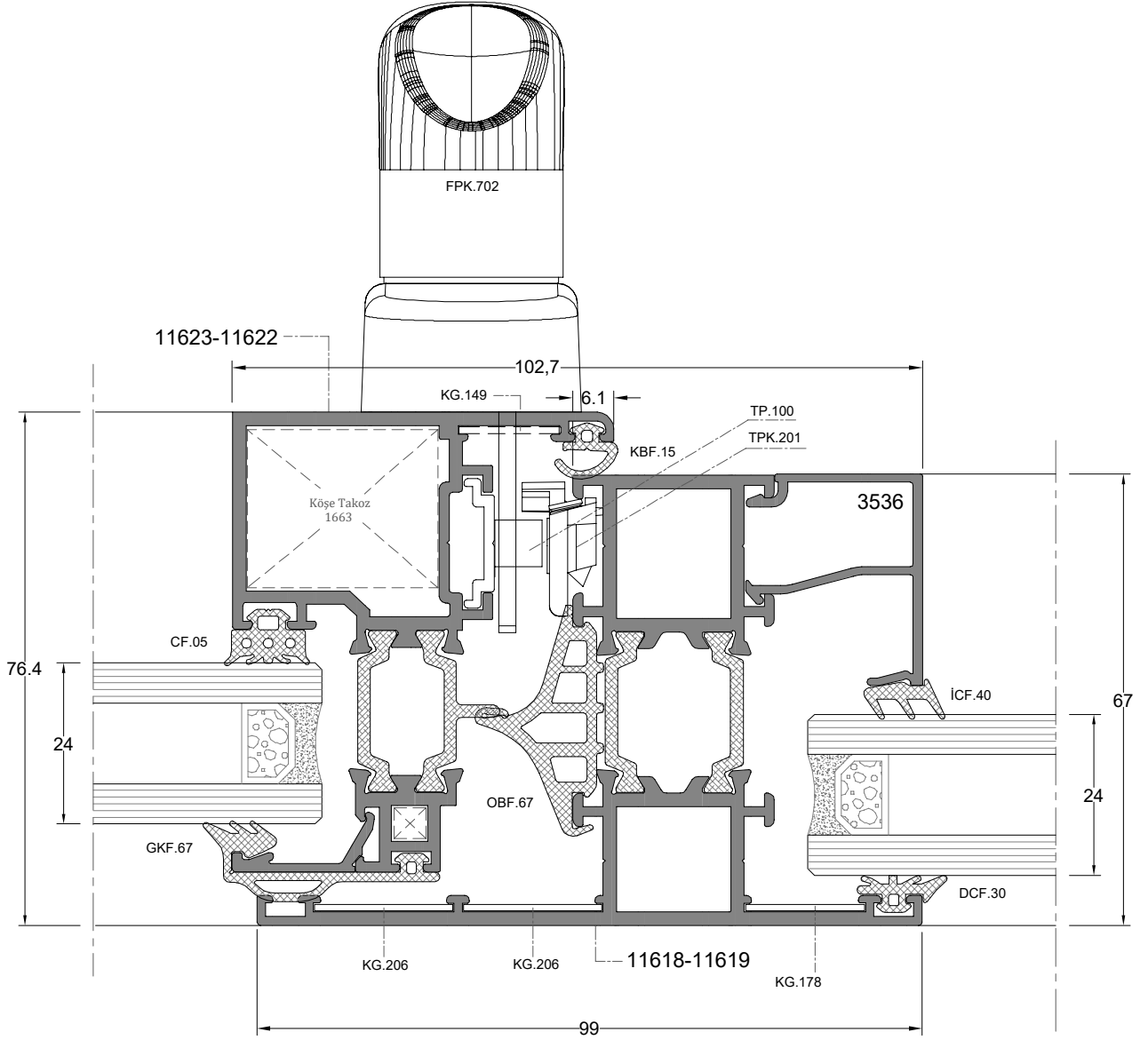

DIŞ
(OUTSIDE)

D-3

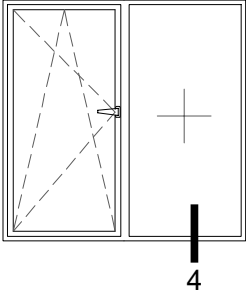

İÇ
(INSIDE)

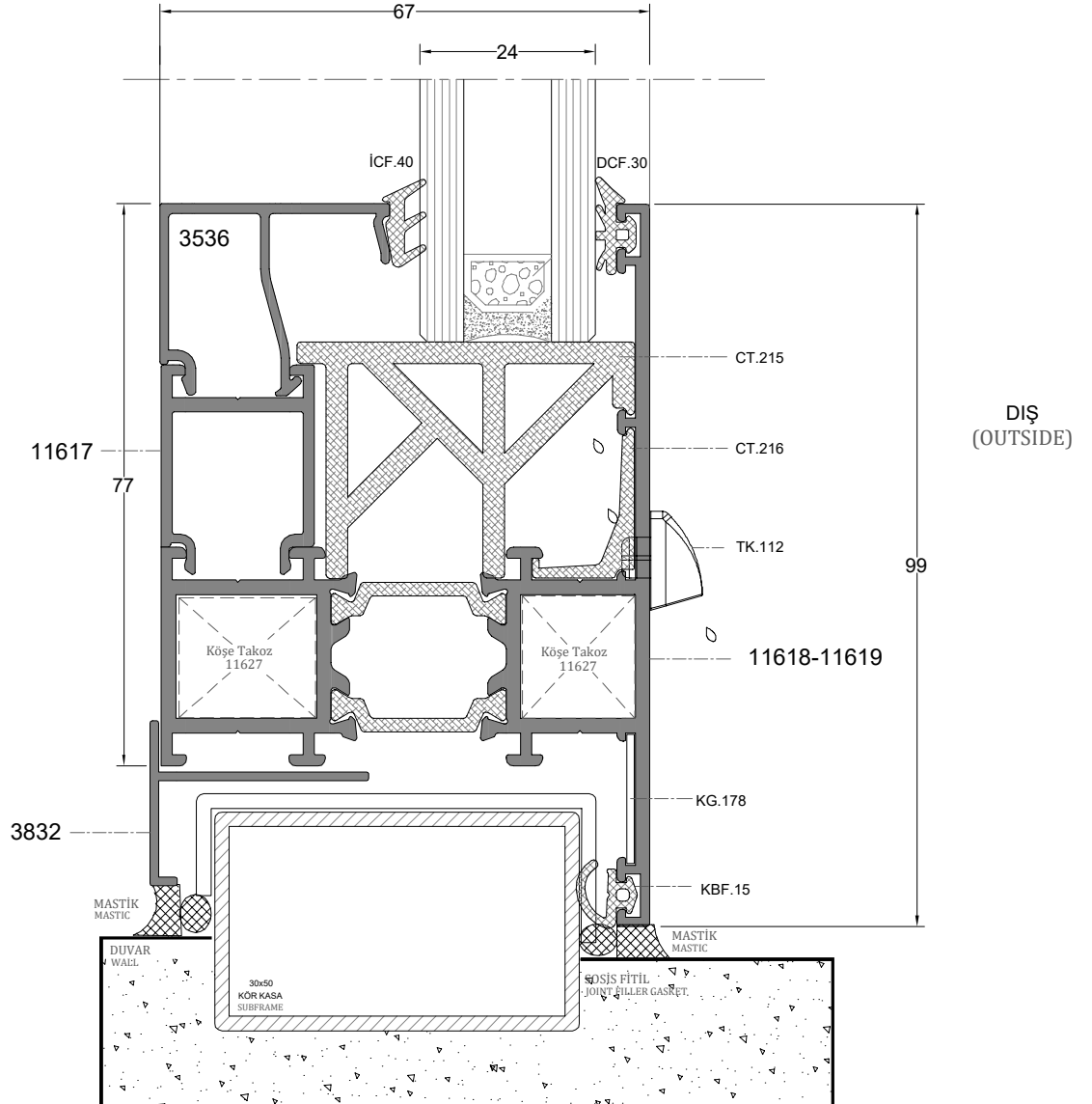

DIŞ
(OUTSIDE)

D-4

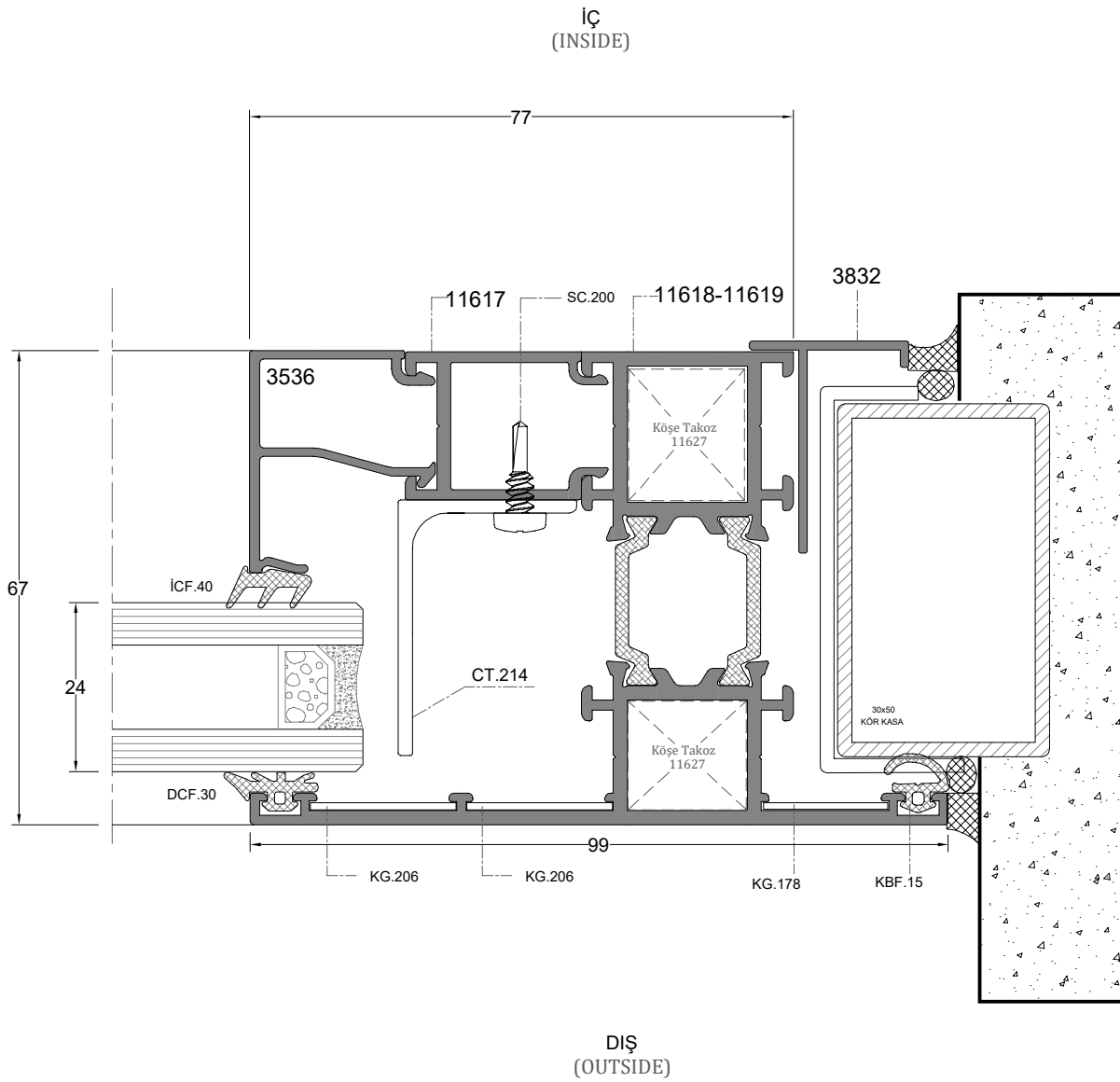
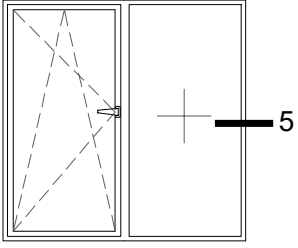

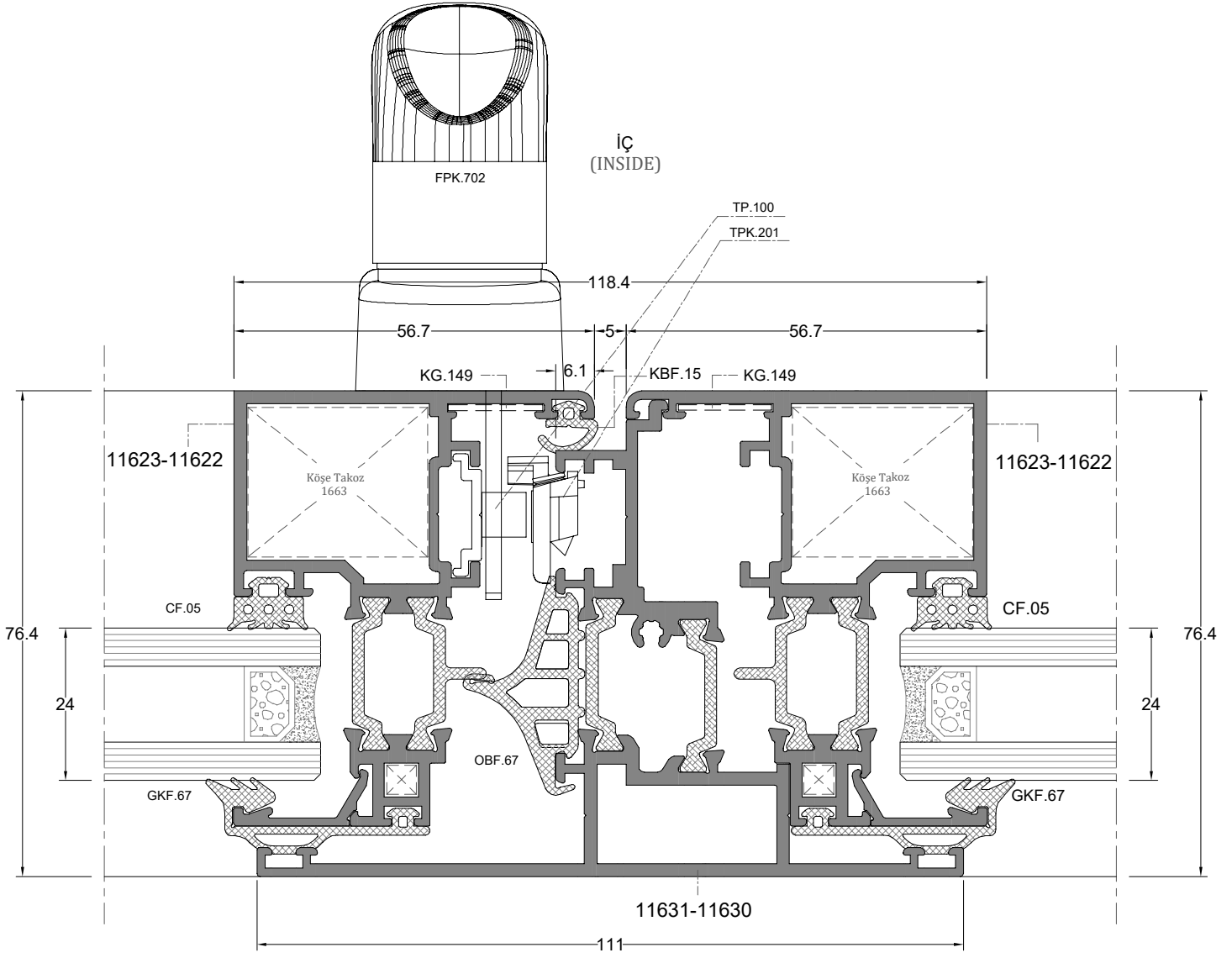
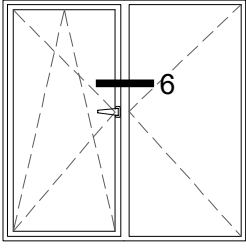

D-6

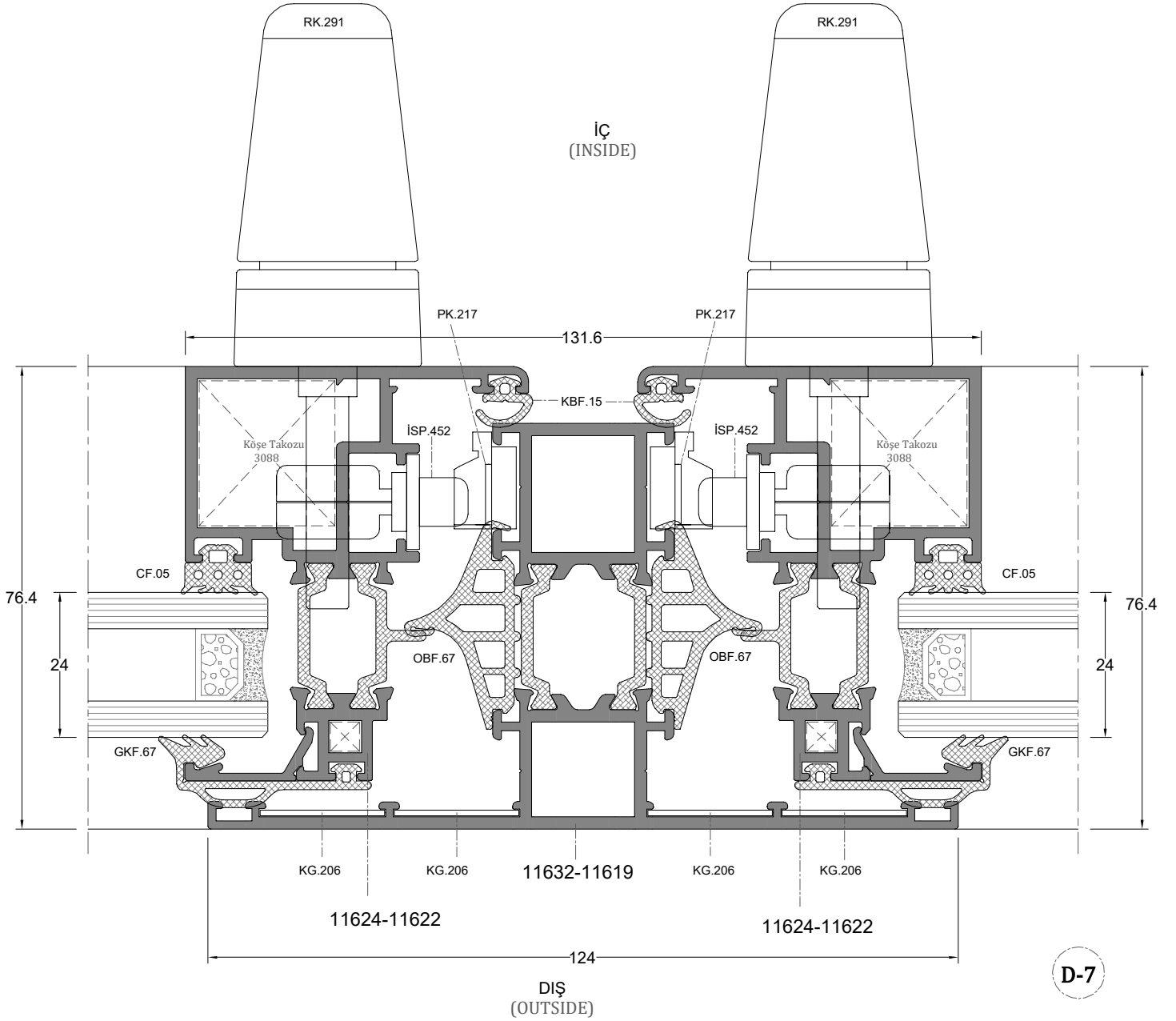
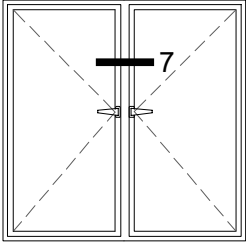

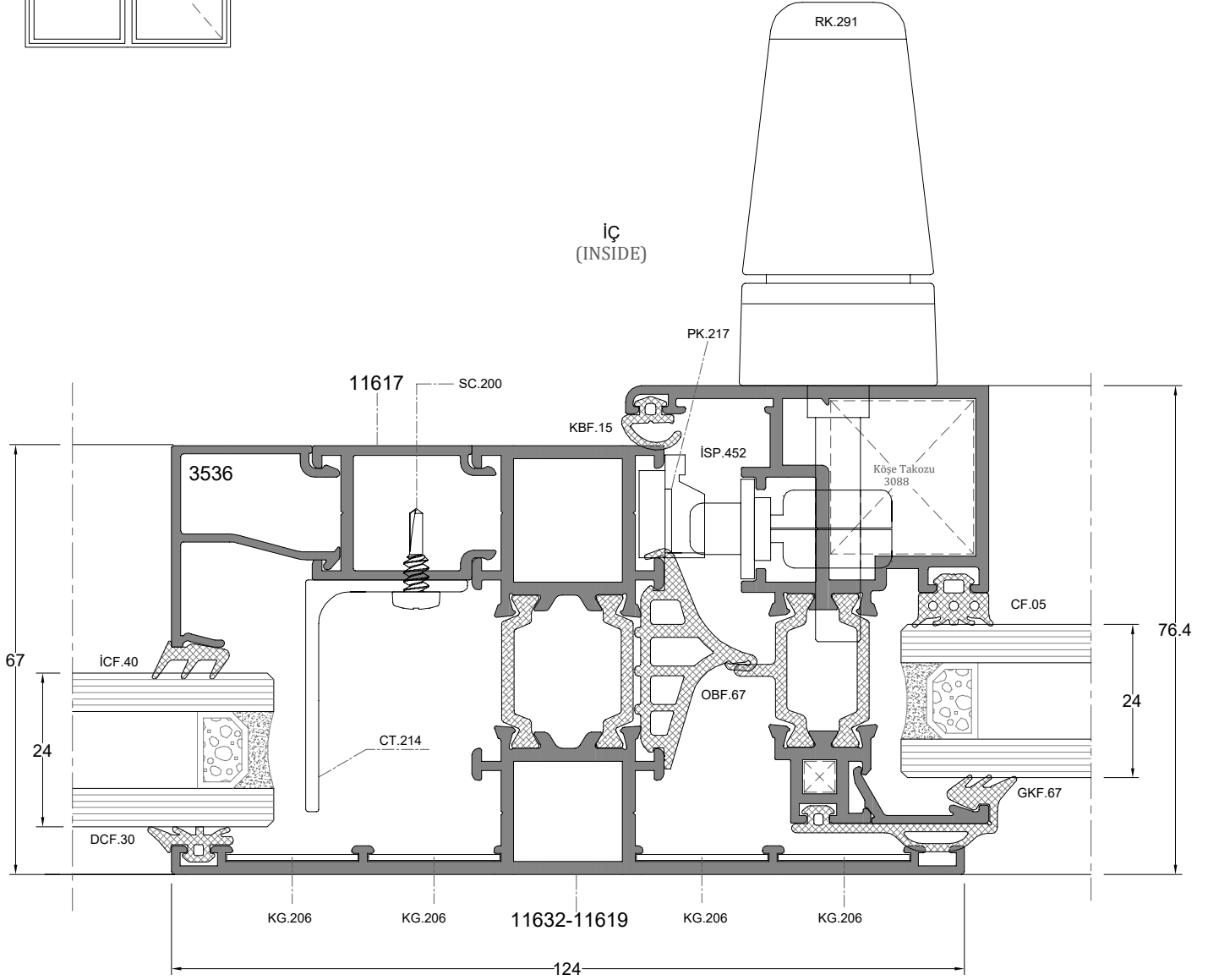
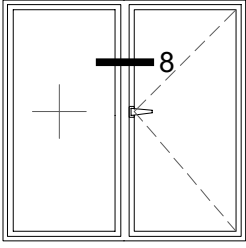

DİŞ
(OUTSIDE)

D-8

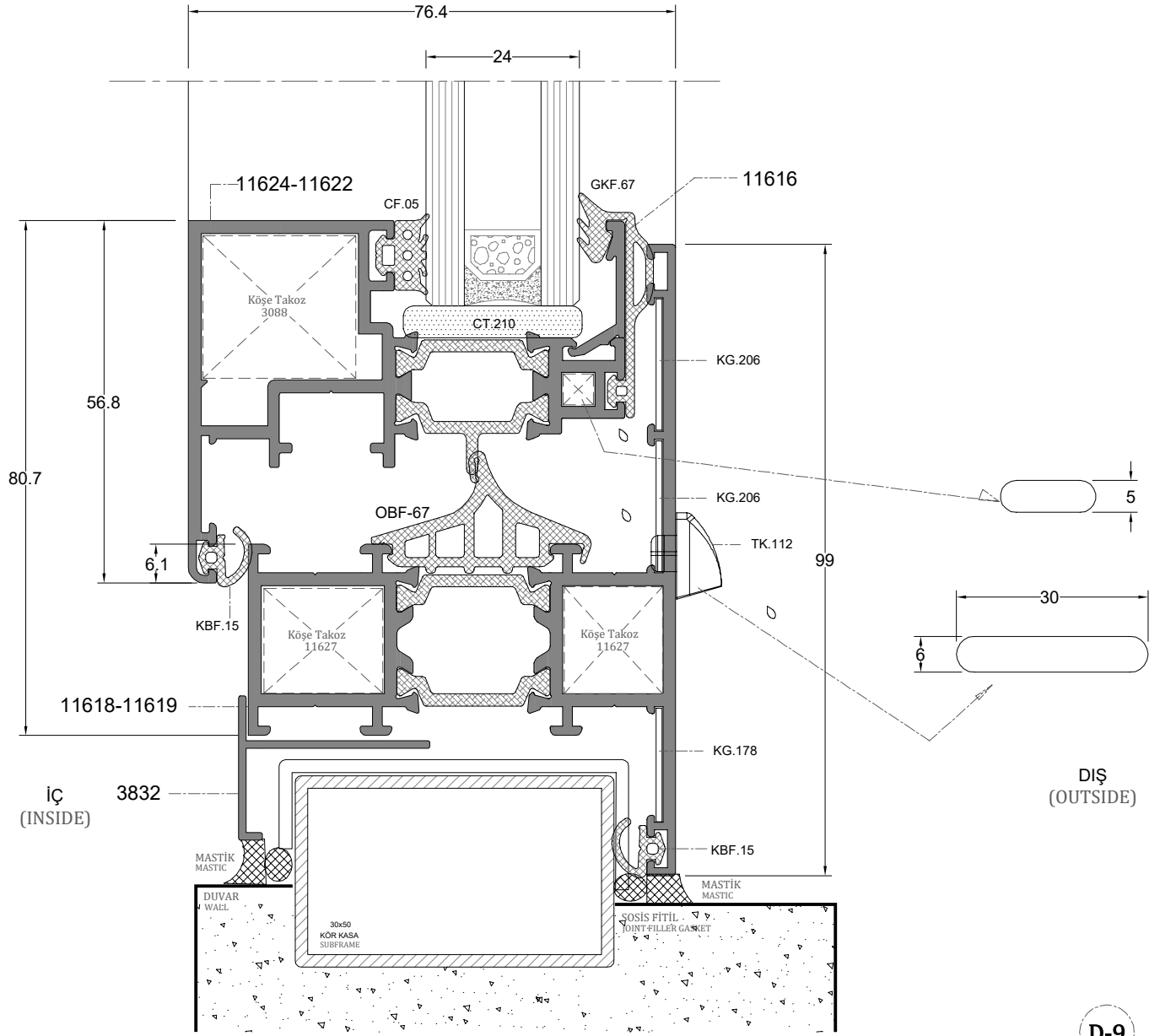
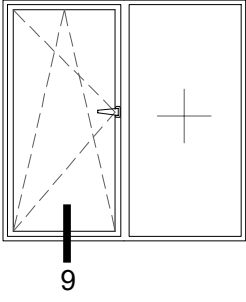

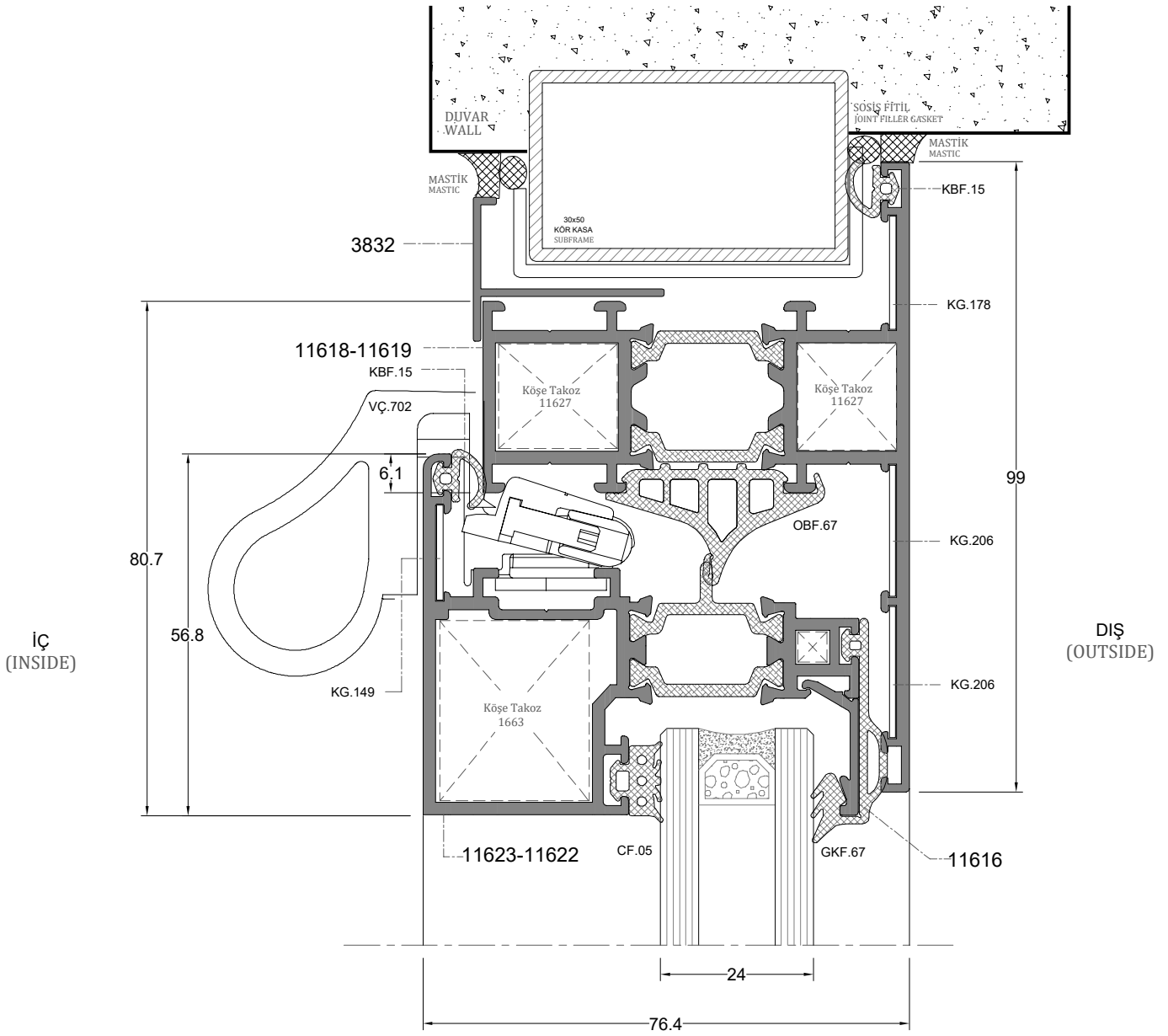
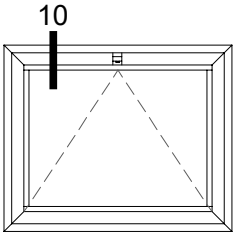

D-10